

APPENDIX 18

FINAL REPORT ON THE DEVELOPMENT OF AN AIRSPACE CONCEPT OF OPERATIONS FOR THE CAPE WINELANDS AIRPORT



Final Report

Development of an Airspace CONOPS for the Cape Winelands Airport

08 October 2024 – REVISED FINAL

Contents

Final Report on the Development of an Airspace Concept of Operations for the Cape Winelands Airport

Glossary				
Introduction				
Executive Summary				
Background				
Industry Consultation				
Current Situation	Airspace	Terrain and Obstacles	Aerodromes	
	FACT Operations	FAWN Operations	FASH Operations	FAYP Operations
Future Developments	Industry Developments	FAWN	FACT	
Concept of Operations	IFR Procedures	VFR Traffic	Merging Traffic	TAAM Simulation
	Alternative Traffic	Airspace	CNS-ATM Systems	ATC
Implementation				
Appendix				

Colophon

Document Title: CWA Airspace CONOPS Revised Final Report

Date: 08 October 2024

Project Name: Aviation Specialist Studies in support of the Environmental Impact Assessment at Cape Winelands Airport

Project Number: MD5423

Client: Cape Winelands Airport Ltd.

Represented by: Mark Wilkinson

Consultants: Royal HaskoningDHV (Pty) Ltd
Operating as NACO, Netherlands
Airport Consultants

Royal NLR – Netherlands Aerospace Centre

Air Traffic and Navigation Services
SOC Ltd.

Authors: Francois Barwise
Marcel Langeslag
Stefan Meeuwissen
Yasudha Sahi
Sindiswa Siwisa
Jeroen van der Zee

Contact: Marcel Langeslag
Director Aviation Africa
T: +27 (0)87 352 1531
M: +27 (0)76 481 3743
E: marcel.langeslag@rhdhv.com
W: www.naco.nl

Glossary

Acronyms and abbreviations

Acronym	Description
AAM	Advanced Air Mobility
ACSA	Airports Company South Africa SOC Ltd.
AFTN	Aeronautical Fixed Telecommunication Network
AGL	Above Ground Level
AeGL	Aeronautical Ground Lighting
AIM	Aeronautical Information Management
AIP	Aeronautical Information Publication
ALT	Altitude
AMHS	ATS Message Handling System
AMSL	Above Mean Sea Level
ANSP	Air Navigation Service Provider
APCH	Approach
ATC	Air Traffic Control
ATCO	Air Traffic Control Officer
ATIS	Automatic Terminal Information Service
ATM	Air Traffic Management / Air Traffic Movement
ATNS	Air Traffic Navigation Services SOC Ltd.
ATS	Air Traffic Service
ATZ	Aerodrome Traffic Zone
AWOS	Automatic Weather Observation System
BARO / Baro	Barometric
CAT	Category
CCO	Continuous Climb Operations
CDM	Collaborative Decision Making
CDO	Continuous Descent Operations

Acronym	Description
CNS	Communication, Navigation and Surveillance
CTIA	Cape Town International Airport
CONOPS / Conops	Concept of Operations
CTR	Controlled Traffic Region / Control Zone
CWA	Cape Winelands Airport
DH	Decision Height
DVOR	Doppler VOR
DME	Distance Measuring Equipment
EIA	Environmental Impact Assessment
EVTOL	Electric Vertical Take-Off and Landing
FA	ICAO location indicator for South Africa
FACT	Cape Town International Airport
FAD	FA Danger area
FAP	FA Prohibited area
FAR	FA Restricted area
FASH	Stellenbosch Airport
FAWN	Cape Winelands Airport
FAYP	Ysterplaat Air Force Base
FBO	Fixed Based Operator
FT / ft	Feet
GBAS	Ground Based Augmentation System
GNSS	Global Navigation Satellite System
GPS	Global Positioning System
IATA	International Air Transport Association
ICAO	International Civil Aviation Organization

Glossary

Acronyms and abbreviations

Acronym	Description
IFR	Instrument Flight Rules
ILS	Instrument Landing System
LED	Light Emitting Diode
LNAV	Lateral Navigation
LOC	Localiser
MACG	Missed Approach Climb Gradient
MET / Met / Meteo	Meteorological (services, systems or equipment)
NM / nm	Nautical Mile
NACO	Netherlands Airport Consultants
NASCOM	National Airspace Committee
NEMPA	National Environmental Management: Protected Areas
NLR	Netherlands Aerospace Centre
NRR	New Realigned Runway (at CTIA)
OLS	Obstacle Limitation Surface
PAPI	Precision Approach Path Indicator
PAX / Pax	Passengers
PBN	Performance Based Navigation
PDG	Procedure Design Gradient
RNAV	Area Navigation
RPAS	Remotely Piloted Aircraft System
RVR	Runway Visual Range
RWY	Runway
RX	Receiver
SA	South Africa
SACAA	South African Civil Aviation Authority

Acronym	Description
SAL	Simple Approach Lighting
SBAS	Satellite Based Augmentation System
SID	Standard Instrument Departure Procedure
SRA	Special Rules Area
STAR	Standard Arrival Procedure
TAAM	Total Airspace and Airport Modeler
THR	Threshold
TMA	Terminal Manoeuvring Area / Terminal Control Area
TWY	Taxiway
TX	Transmitter
UAM	Urban Air Mobility
VFR	Visual Flight Rules
VHF	Very High Frequency
VNAV	Vertical Navigation
VOR	VHF Omnidirectional Range
WGS	World Geodetic System

Introduction

Introduction

This report describes the Airspace Concept of Operations for the Cape Winelands Airport

Environmental Impact Assessment

The development of an Airspace CONOPS forms part of the Aviation Specialist Studies in support of the Environmental Impact Assessment for the Cape Winelands Airport. This Airspace CONOPS forms part of the Assessment Phase of the Environmental Impact Assessment. It is explicitly stated that airspace approval is not required as part of the EIA process. The Airspace CONOPS is provided purely for informational purposes to assist and support the environmental approval for the proposed Cape Winelands Airport Development. The process of applying for airspace approval will be handled entirely separately through the formal NASCOM (National Airspace Committee) process, which is completely independent of the EIA. The NASCOM process is a consultative one, involving input from the aviation industry, and operates according to its own distinct timelines and requirements, with no dependency on the EIA process.

This Report has been prepared jointly by three firms:

- NACO, Netherlands Airport Consultants
- NLR, Dutch Aerospace Centre
- Air Traffic and Navigation Services (ATNS)

Under our appointment by Cape Winelands Airport the scope of the aviation specialist studies includes the following:

- Baseline Assessment (completed)
- WGS84 Survey and Obstacle Limitation Surfaces (OLS) analysis (completed)
- Airspace CONOPS (this report)
- Noise Modelling (by others)

The Department of Forestry, Fisheries and Environment (DFFE) screening report for the Cape Winelands Airport Expansion, generated on 5 May 2022, indicated High sensitivity of the proposed site with regards to civil aviation.

This prompted the need for specialist inputs in terms of the Protocol for the Specialist Assessment and Minimum Report Content Requirements for Environmental Impacts on Civil Aviation Installations (Published in Government Notice No. 320 Government Gazette 43110, 20 March 2020).

Airspace Concept of Operations

The proposed expansion of Cape Winelands Airport (CWA) entails developing the existing aerodrome and adjacent plots of land into a thriving commercial and aviation hub, supporting flight operations domestically as well as internationally. In order to facilitate this the airport will need to transition from its current state, with uncontrolled airspace and only visual flight rules operations, to a future state with controlled airspace and instrument procedures in place. This Airspace CONOPS enables CWA to define its requirements and plan its approach to the transition.

The Airspace CONOPS can be seen as a master plan or schema of the intended airspace and its operation. It describes the procedures required to facilitate the various traffic flows that are expected and the CNS-ATM enablers.

Revised Final Report

An Interim Report was submitted to the Client on 7 September 2022. That report intended to form an understanding of the current situation in terms of airspace surrounding CWA. The Final Report issued on 11 November 2022 focuses on the proposed changes to the status quo that may be required to facilitate the development of the airport. It presents the proposed concept of operations for the airspace and is intended as a basis for further stakeholder engagement and a starting point for the airspace and flight procedure design process. The concept of operations presented here is not a 'final product' that is cast in stone but rather an initial proposal that can be altered, refined and developed further.

[This Revised Final Report of 08 October 2024 reflects revisions to CWA's development plans and further stakeholder inputs received.](#)

Introduction

This report describes the Airspace Concept of Operations for the Cape Winelands Airport

South African National Airspace Masterplan

The CONOPS outlines the seamless integration of the airspace around CWA with the existing controlled airspace around Cape Town. The integration seeks to ensure safe, efficient, and harmonious air traffic management while accommodating the growing demand for air travel and aviation activities in the region, while at all times adhering to the South African National Airspace Masterplan (NAMP). The National Airspace Master Plan (NAMP) is a comprehensive and strategic document developed by the South African Civil Aviation Authority that guides the development, management, and optimization of its entire airspace system. The primary purpose of a NAMP is to provide a long-term vision and framework for the safe, efficient, and sustainable use of the national airspace to meet current and future air traffic demand. The South African NAMP (3rd Edition, 2020) describes the national airspace user's expectations as follow:

- 1. Access and equity:** The ATM system managed by ATNS in close collaboration with the SACAA and any other ATS service providers, must provide an operating environment that ensures that all airspace users have the right of access to ATM resources needed to meet their specific operational requirements; and ensures that the shared use of the airspace for different airspace users can be achieved safely.
- 2. Capacity:** The ATM system managers must plan to exploit the inherent capacity to meet airspace user demand at peak times and demanding locations while minimising restrictions on traffic flow. To respond to future growth, capacity must increase, along with corresponding increases in efficiency, flexibility, and predictability while ensuring that there are no adverse impacts to safety giving due consideration to the environment.
- 3. Cost effectiveness:** The ATM system must be cost-effective, while balancing the varied interests of the ATM community and varying level of services provided. The cost of service to airspace users should always be a consideration and appropriately collaborated upon when evaluating any proposal to improve ATM service quality or performance.
- 4. Efficiency:** Efficiency addresses the operational and economic cost-effectiveness of gate-to-gate flight operations from a single-flight perspective. Airspace users want to depart and arrive at the times they select and fly the trajectory they determine to be optimum in all phases of flight. The ATM System service providers must maintain relevant data sets to be able to compare requested service levels and trajectories with those delivered for planning and regulator reporting purposes.
- 5. Environment:** The ATM system must consider and plan to contribute to the protection of the environment by considering flight profiles, noise, gaseous emissions, and other environmental matters in the implementation and operations.
- 6. Flexibility:** Whilst the need to manage resource allocations both from an ATM system management and aerodrome point of view, flexibility addresses the ability of all airspace users to modify flight trajectories dynamically and adjust departure and arrival times thereby permitting them to exploit operational opportunities as they occur and possibly improve business outcomes. Plans need to consider the opportunities the future technology presents.
- 7. Global interoperability:** The ATM system design must be based on all the requirements and global guidance material, global standards and uniform principles to ensure the technical and operational interoperability of ATM systems and to facilitate homogeneous, global and regional traffic flows.
- 8. Participation by the ATM community:** The ATM community must have a continuous involvement in the planning, implementation, and operation of the management of airspace and associated services to ensure that the evolution of the global ATM system meets the expectations of the community.
- 9. Predictability:** Whilst any plan must have contingencies in place to manage unexpected events, predictability is an absolute requirement for the entire ATM System to operate successfully. Consequently, it is a serious expectation that there is a robust level of predictability built into the community's (users and service providers) strategic and tactical plans.

Introduction

This report describes the Airspace Concept of Operations for the Cape Winelands Airport

- 10. Safety:** Safety is the highest priority in aviation, and ATM plays an important part in ensuring overall aviation safety. Uniform safety standards and risk and safety management practices should be applied systematically throughout the ATM system. In implementing elements of the global aviation system, safety will be assessed against appropriate criteria, and in accordance with appropriate and globally standardised safety management processes and practices. It is a requirement that any implementation of a system solutions, procedural, technical or otherwise, irrespective of any business case and collaborated acquisition agreement, will be supported by a SACAA approved safety case.
- 11. Security:** Adequate Security in aviation is a major expectation and there are certain aspects of security that will only become evident and manageable by the ATM System. Normally referring to the protection against threats, which stem from intentional (e.g. terrorism) or unintentional (e.g. human error, natural disaster) acts affecting the safety of aircraft, people or installations on the ground. The ATM system must contribute to security, including the threat of cyber security.

Design Principles

The founding principles for delivering exceptional airport and air navigation services at CWA are centered on safety, efficiency, customer-centricity, sustainability, and innovation. These principles will guide the development and operation of CWA to ensure a seamless, consistent and world-class experience for all stakeholders involved.

Safety First: The highest priority is the safety of passengers, crew, and all personnel. Striving for uncompromising safety standards and adhering to international aviation regulations and best practices will be the cornerstone of all operations.

Operational Efficiency: Efficiency in all aspects of airport, airspace and air navigation services will be pursued. This includes optimizing design processes to enhance overall operational effectiveness. By observing the identified design strategies and fostering a culture of collaboration, innovation, and continuous improvement, CWA can achieve high levels of operational efficiency, leading to safer, more economical, and environmentally friendly air travel.

Customer-Centric Approach: Passengers, airlines, and other users are at the heart of all decisions. Understanding and exceeding their expectations through exceptional services, seamless processes, and personalized experiences shaped by many years' experience will be a fundamental principle.

Sustainability and Environmental Responsibility: Operating CWA with environmental consciousness is integral. Efforts to reduce carbon footprint, adopt eco-friendly practices, and minimize the airport's impact on the local ecosystem will be actively pursued.

Innovation and Technology Integration: Embracing cutting-edge technologies and innovative solutions will drive continuous improvement in services. This includes adopting smart systems for navigation, communication, passenger services, and operations to enhance efficiency and passenger experiences. The introduction of a first-ever remote or digital tower solution in South Africa and Africa is one element of the innovative approach.

Collaboration and Stakeholder Engagement: An open and collaborative approach with local communities, regulatory bodies, airlines, air traffic control agencies, other airport authorities, and other stakeholders will be cultivated. Their insights, feedback, and partnership will be a cornerstone for the success of CWA.

Introduction

This report describes the Airspace Concept of Operations for the Cape Winelands Airport

Training and Skill Development: Investing in training and skill development for the workforce will ensure that CWA maintains a high level of expertise in all operational areas, leading to improved service delivery. Safety experts will champion ongoing safety awareness and training.

Continuous Improvement: A commitment to continuous improvement will be fostered through regular reviews, feedback analysis, and performance assessments. Adaptation to changing industry trends and emerging technologies will be a consistent endeavour.

Ethical and Transparent Practices: CWA will uphold the highest standards of ethics, integrity, and transparency in all its dealings, ensuring trust and credibility among stakeholders. CWA's commitment to the highest standards will contribute to a virtuous cycle of trust, credibility, and positive outcomes. This approach not only benefits the organization's reputation but also creates an environment conducive to growth, collaboration, and sustained success.

Flexibility and Adaptability: The ability to adapt to changing circumstances, whether in terms of passenger demands, technological advancements, or industry regulations, is a core design principle.

Coexistence of Cape Winelands Airport and Cape Town International Airport

The coexistence of Cape Winelands Airport and Cape Town International Airport will be achieved:

1. at a strategic level by means of defined design criteria observed at flight procedure design stage,
2. pre-tactically by means of demand and capacity balancing and
3. tactically by means of the normal processes of
 - a. planning,
 - b. collaboration, and
 - c. effective airspace management.

By implementing the identified strategies, Cape Winelands Airport and Cape Town International Airport can coexist harmoniously, each fulfilling its unique role in the aviation ecosystem while prioritizing safety, efficiency, and collaboration.

Introduction

This CONOPS was developed by NACO, NLR and ATNS. Together, we bring more than 200 years of experience at the forefront of the global aviation industry.



NACO Netherlands Airport Consultants is a firm of airport consultants, economists, planners, architects and engineers. The company was founded in 1949 with the aim of providing specialist know-how and services in the development of airports and all associated facilities within, as well as outside the premises of the airport. NACO is now wholly-owned by the Royal HaskoningDHV Group and forms part of its business line 'Maritime & Aviation'.

The firm has assisted over 600 airports world-wide, geographically located in tropical, moderate and cold climates. NACO's range of services extends to all aspects of airport development, from project initiation, traffic forecasting and economic feasibility studies, to Due Diligence and business consultancy, site selection, Master Planning, engineering and architectural design, preparation of tender documents, pre-qualification of contractors, construction management and supervision.



Royal NLR, Netherlands Aerospace Centre is a global company with over 100 years of experience and approximately 650 people dedicated to airspace innovation. NACO and NLR's partnership has a long track record of successful projects together.

Royal NLR makes aerospace more sustainable, safer, more efficient and more effective. The innovative solutions and practical advice strengthen the competitiveness of the business community and contribute to solutions for social issues. NLR works in an objective manner, for and with the (inter) national business community and government agencies.

The multidisciplinary EASA qualified entity covers the entire airspace development chain from analysis, research and development to qualification and certification.



Air Traffic and Navigation Services SOC Limited (ATNS) provides air traffic, navigation, training and associated services within South Africa and a large part of the Southern Indian and Atlantic Ocean, comprising approximately 10% of the world's airspace.

ATNS operates from nine ACSA and 12 other aerodromes. As a globally competitive employer of choice, ATNS is committed to diversity and has achieved ranking within the top 10 companies in South Africa with regards to female representation at executive levels.

Our services extend beyond air traffic control services into the provision of vitally important aeronautical information used for all flight planning purposes as well as search and rescue coordination activities, and the maintenance of a reliable navigation infrastructure.

Executive Summary

Executive Summary

The Airspace CONOPS aims to propose a comprehensive approach to flight operations at the airport, within the context of the existing situation and future developments

Status Quo

- Uncontrolled airspace at FAWN
- CTR and TMA at FACT
- NEMPA, Prohibited, Restricted and Danger areas
- Terrain and obstacles
- CNS/ATM in the region
- Nearby aerodromes:
 - FACT
 - FAYP
 - FASH

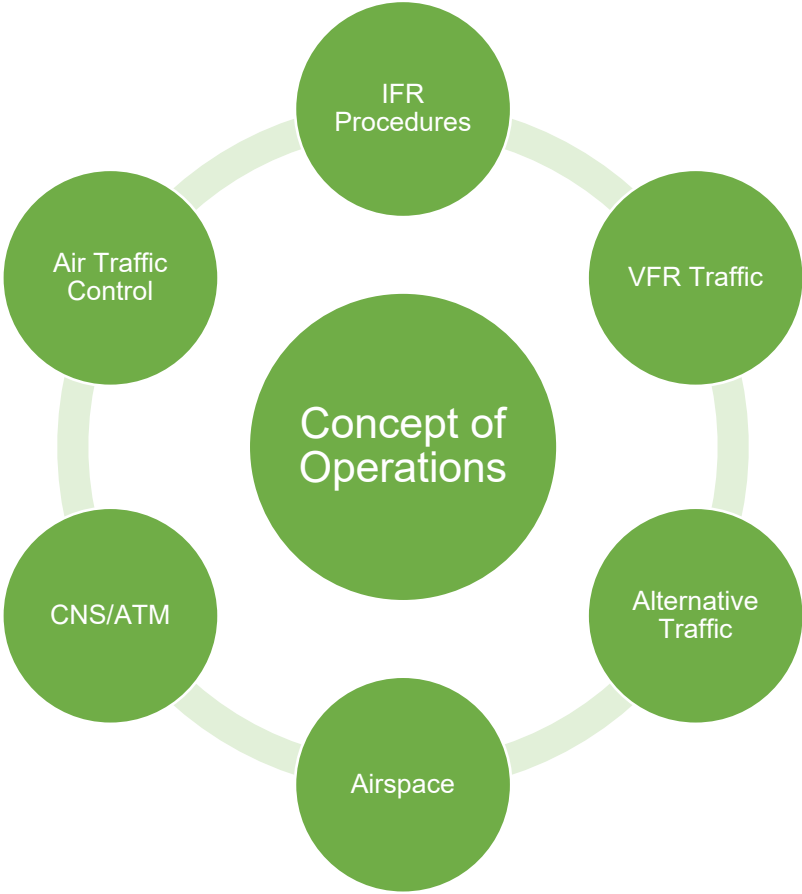

Future Developments

- National Airspace Master Plan
- PBN Roadmap
- Airspace boundary reviews
- Development of FAWN
- New Realigned Runway at FACT

Executive Summary

This Airspace Concept of Operations provides a starting point for the integration of the Cape Winelands Airport into the existing airspace in the Western Cape

This Airspace CONOPS has been developed as part of the Specialist Studies in support of the Environmental Impact Assessment process for the development of the Cape Winelands Airport (CWA). It provides a starting point for further industry consultations and the design of suitable procedures and airspace.

Objectives and Requirements

The strategic objectives of the CONOPS are the following:

1. Transition of CWA/FAWN from its current state to a thriving commercial airport, operating safely within the regional airspace
2. Enable the introduction of scheduled commercial traffic at CWA.
3. Facilitate the growth of VFR traffic at CWA and in the region.
4. Seamless integration of CWA traffic with current operations in the area.

It aims to comply with the following operational requirements:

1. Enable independent operations of FAWN and FACT.
2. Minimize changes to the existing situation in the Western Cape airspace.
3. Minimize ATCO workload.

Status Quo

Currently there is no airspace assigned to FAWN and only VFR operations take place at the airport, mostly for flight school and private aviation activities. The airport is situated within the SRA under the TMA A of CTIA, nearby the CTR of CTIA and the general flying area FAD 69(A). A WGS84 topographical survey of the Obstacle Limitation Surfaces (OLS) has identified several obstacles. Publicly available terrain data has identified significant high terrain to the south and south-east of the airport. These are considered in this CONOPS and are some of the key factors that will drive the design of the procedures.

There are many small aerodromes, as well as model aircraft sites, in the area near FAWN and the key aerodromes to be considered in the CONOPS are Cape Town International Airport (FACT), Ysterplaat Airforce Base (FAYP) and Stellenbosch Airfield (FASH).

Future Developments

The National Airspace Master Plan contains several important considerations to be taken into account. The NAMP prescribes a Collaborative Decision Making (CDM) approach to all airspace developments. It foresees a review of all airspace boundaries in the country and the implementation of RNAV operations under the PBN Roadmap. Future aviation developments including unmanned operations are expected to be integrated in all types of airspace.

The proposed development of CWA aims to increase the available capacity for both unscheduled and scheduled operations. The airport will facilitate both General Aviation (GA) users and commercial operations, including domestic and international traffic. The airport will serve as an alternate in case of flight diversions, which will provide significant benefits to the industry.

Airport infrastructure that is expected to be developed includes a runway, for code 4E instrument operations, of approximately 3000m length and with orientation 01-19.

Future growth of traffic at CTIA is expected to trigger the implementation of a New Realigned Runway at the airport, with orientation 18-36. High-level designs of both airport infrastructure and instrument flight procedures have been developed. At this stage it is unknown exactly when the development will go ahead. Once the NRR is operational, the existing runways 01-19 and 16-34 are expected to be decommissioned.

Executive Summary

The implementation of IFR procedures at FAWN will require re-design of the airspace in the area

IFR Procedures

To facilitate the forecast (commercial) air traffic at the airport, it is proposed to implement instrument flight procedures for runways 01 and 19. Traffic utilizing these procedures will merge into existing departure and arrival routes to and from FACT.

The proposed procedures include RNP approaches, and RNAV SIDs and STARs. The addition of ILS procedures, CAT I or II, will provide benefit, especially to operators without RNP APCH + Baro-VNAV capabilities.

VOR procedures may be considered as back-up, or in case sufficient demand exists within the industry.

Conceptual procedures have been developed to assess their general feasibility and provide a starting point for further design development. The following observations have been made:

1. Keeping IFR traffic outside or below the FACT airspace will not be possible.
2. Departure from RWY 01: Avoiding FAD 69(A) does not seem feasible.
3. Departure from RWY 19: An early left turn to the east does not seem feasible and flights need to clear high terrain before joining TETAN or OKTED.
4. Approach to RWY 01: The missed approach procedure will likely interfere with one or more FADs. A turn as soon as practicable avoiding the FADs does not seem feasible.
5. Approach to RWY 19: Any instrument approach procedure to RWY 19 will interfere with one or more FADs

VFR & Alternative Traffic

With the proposed main runway at FAWN in a North-South orientation it is advisable that VFR traffic join from the East or West. All VFR traffic routing in the area must remain clear of the proposed controlled airspace for FAWN and clearance into and out of the airport must be obtained from ATC.

The major flows of VFR traffic are expected to be to and from the general flying areas and other training areas towards the East of FAWN. Once the FAWN airspace has been finalised and implemented standard VFR routes may be developed.

Alternative traffic flows that are to be accommodated at FAWN included helicopter operations (either VFR or IFR) and Advanced/Urban Air Mobility (UAM/AAM) operations. The UAM/AAM operations may include (electric) vertical take-off and landing aircraft, as well as unmanned or remotely piloted aircraft (RPAS). Regulations, standards and recommended practices for these novel traffic types are still under development.

Airspace

Controlled airspace will have to be designed to contain the IFR procedures at FAWN. It is proposed that an ATZ is considered, this ATZ should be aligned with the FACT CTR and will likely range from ground to 2500 FT ALT, the lower level of the FACT TMA A. Standard operating procedures must be developed to ensure efficient transition from the FACT TMA to the FAWN ATZ. Moreover, the FAD 69(A), and potentially other areas, may have to be redesigned in order for the instrument procedures at FAWN to be implemented.

Airspace may impose certain restrictions on the flow of VFR traffic around the Cape Town CTR and FAWN ATZ.

The capacity of the airspace in the entire region must be re-evaluated and studied in more detail due to the additional traffic flows from FAWN and future prospects of FACT. This needs to be considered also taking into account the multitude of factors affecting airspace capacity.

Executive Summary

Implementing the proposed procedures and airspace will require industry consultation through formal channels and the regular procedure and airspace design processes

CNS/ATM

To facilitate the expected traffic flows at FAWN with the proposed precision approach procedures, it is recommended to install an instrument landing system (ILS) with CAT II, or potentially III. It should be evaluated whether this is desirable only for the predominant operating direction (RWY 19) or for both directions.

Ground-Based Augmentation System (GBAS) is a Global Navigation Satellite System (GNSS)-based precision landing system and is standardized by ICAO as a replacement for the ILS and DVOR. Future implementation of GBAS should be considered in the further development of the airport., while taking into account developments in SBAS.

Additional systems required for the precision approach include aeronautical ground lighting (AeGL) with approach lights, precision approach path indicators and an Automated Weather Observation System (AWOS) complete with all relevant sensors.

VOR and/or DME equipment may be considered for the airport and will be required if VOR procedures are implemented. In the absence of such procedures, it could be considered for aircraft to make use of already existing equipment in the area.

The full range of Air Traffic Communication Systems will likely be required at the airport to enable air traffic control to operate the proposed controlled airspace.

Air Traffic Control

It is recommended that local ATC is implemented at FAWN to operate the proposed controlled airspace. This could be facilitated with a conventional physical tower, or remote/digital tower solutions can be considered. Remote/digital tower solutions are developing rapidly and have been deployed successfully in many countries.

Operating procedures would have to be developed to ensure seamless integration of ATC at FAWN and FACT. ATCO capacity and workload will be key considerations in this regard.

Implementation

Implementation of the Airspace CONOPS proposed in this report will require formal procedures to be followed, including engagement of NASCOM and the CNS-ATM Implementation Committee. Extensive engagement with industry stakeholders and the public should form part of the further process, guided by CDM principles. The anticipated TAAM simulation may assist in this process by providing a visualization of proposals.

Additional studies will be required to gain insight into fleet capabilities of target operators and airspace capacity. In this context ATCO workload and means of optimization should be carefully considered.

Several areas of attention have been identified that should be dealt with during further design development of flight procedures and airspace. These include the optimization of merge and diversion points, the optimization of climb gradients for aircraft performance and noise footprints, establishment of a CTR/ATZ for FAWN, the combined use of the TMA by both FACT and FAWN and the possible reconfiguration of FAD 69(A).

Background

Background of Cape Winelands Airport

The Baseline Assessment Report provides a comprehensive background to the existing situation on the ground and the proposed development of CWA

Cape Winelands Airport

- Former Fisantekraal Airport
- Built <1943 (SAAF)
- 1960 - Local Municipality
- 1993 - Private Owners
- 2020 - Cape Winelands Airport Limited

Category 1 Aerodrome License

- SACAA - 0820
- FAWN

Airspace

- Nil
- Cape Town Special Rules Area
- Uncontrolled
- Class G

Location

- 5 nautical miles (NM) NE Durbanville
- Elevation = 399 feet (122 meters) AMSL

Project location (depicted in blue) and nearby aerodromes

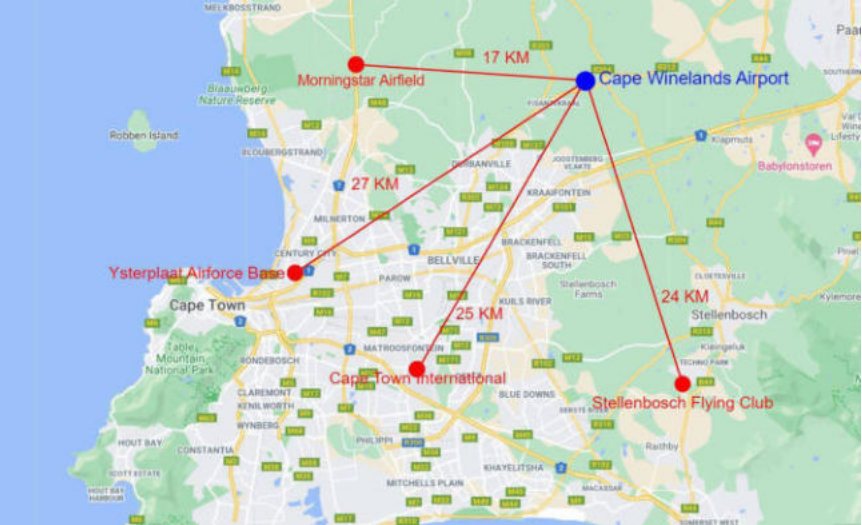

Project location (depicted in yellow) and immediate environment

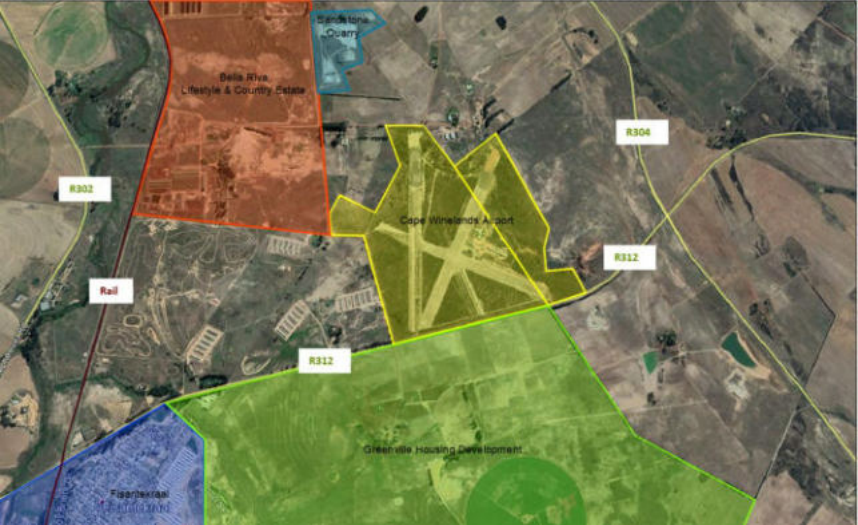

Key Principles

The following national airspace management and users' expectations are important principles that guide the development of the Airspace CONOPS for Cape Winelands Airport

- **Access and equity**

- All airspace users have the right of access to ATM resources needed to meet their specific operational requirements.
- The shared use of the airspace for different airspace users can be achieved safely.

- **Capacity**

- To respond to future growth, capacity must increase, along with corresponding increases in efficiency, flexibility, and predictability while ensuring that there are no adverse impacts to safety giving due consideration to the environment.

- **Cost effectiveness**

- The cost of service to airspace users should always be a consideration and appropriately collaborated upon when evaluating any proposal to improve ATM service quality or performance.

- **Efficiency**

- The operational and economic cost-effectiveness of gate-to-gate flight operations from a single-flight perspective.

- **Environment**

- The ATM system must consider and plan to contribute to the protection of the environment by considering flight profiles, noise, gaseous emissions, and other environmental matters in the implementation and operations.

- **Flexibility**

- The ability of all airspace users to modify flight trajectories dynamically and adjust departure and arrival times thereby permitting them to exploit operational opportunities as they occur and possibly improve business outcomes.

- **Global interoperability**

- The ATM system design must be based on all the requirements and global guidance material, global standards and uniform principles to ensure the technical and operational interoperability of ATM systems and to facilitate homogeneous, global and regional traffic flows.

- **Participation by the ATM community**

- The ATM community must have a continuous involvement in the planning, implementation, and operation of the management of airspace and associated services to ensure that the evolution of the global ATM system meets the expectations of the community.

- **Predictability**

- Whilst any plan must have contingencies in place to manage unexpected events, predictability is an absolute requirement for the entire ATM System to operate successfully.

- **Safety**

- Safety is the highest priority in aviation, and ATM plays an important part in ensuring overall aviation safety.

- **Security**

- Security risk management should balance the needs of the members of the ATM community who require access to the system, with the need to protect the ATM system.

Industry Consultation

Industry Consultation

Preliminary stakeholder engagements were conducted to gather information and feedback on the proposed Airspace CONOPS as it was being developed

During the process of the development of the Airspace CONOPS, preliminary engagements took place with the following stakeholder groups:

- Air traffic control at CTIA
- Airports Company South Africa (ACSA) representatives at CTIA
- Major domestic airline flight-ops team

The information and feedback received from these stakeholders was considered in the development of the CONOPS and is summarized below. It is expected that further, more comprehensive and more detailed, stakeholder engagements will take place following the completion of this Airspace CONOPS and leading into the design of procedures for the airspace.

Airspace and procedure design:

- Cape Town approach operations are mostly one (1) sector configuration. Director sectors are available for increased demand on both runways.
- Flows to be considered include traffic within the SRA (known/unidentified) and traffic within the TMA (known/identified).
- The availability of navigational aids must be considered in procedure design, e.g. withdrawal of RIV, etc.
- Surveillance coverage surrounding Cape Town International Airport appears to be sufficient for Air Traffic Control. Cape Winelands Airport Traffic has been detected from 600 feet, 200 feet above ground.
- Communication tools are well established within the Cape Town Airspace.

Airspace capacity:

- Cape Winelands Airport must be developed to ensure there are no dependencies between FACT and FAWN.
- CTIA intends to grow and the establishment of Cape Winelands Airport and the associated airspace should not compromise its current capacity or intended growth.
- Local air traffic control at FAWN will be required. Remote Air Traffic Services have not yet been certified in South Africa.
- Staffing requirements for Air Traffic Control at FAWN must be considered to ensure capacity is not compromised at FACT.

Safety:

- VFR traffic in the area must be considered as it plays an important role in the safety of flight operations. This includes the consideration that some of the traffic will be training flights by unexperienced pilots.
- Approach from Gauteng into FACT passes relatively low over FAWN (approx. 4500ft). VFR operations into FACT RWY 19 might pass even lower. Vertical separation in the airspace must be carefully considered.

Environment:

- The routes for FAWN should have an optimized design to accommodate Continuous Descent Operations (CDO) and Continuous Climb Operation (CCO) as much as possible. With this the impact on the environment will be as small as possible.
- The fog that causes low visibility conditions at FACT (and FAYP) at times is not as bad at FAWN.

Industry Consultation

Preliminary stakeholder engagements were conducted to gather information and feedback on the proposed Airspace CONOPS as it was being developed

Navigation

The Cape Winelands Airport requires a comprehensive Navigation Strategy that integrates Performance-Based Navigation (PBN) procedures with the existing airspace infrastructure. Developing an integrated air navigation strategy requires a comprehensive and multidisciplinary approach. Guiding the design work will be the unique characteristics and challenges of the airport, the surrounding airspace, and the broader aviation ecosystem to ensure a successful and sustainable strategy. The PBN navigation concept has three pillars:

1. Navigation Specification – what is the navigation performance required in the airspace i.e.. How accurate does the aircraft need to fly the routes?
2. Navigation Application – what kind of procedure can actually be flown?
3. Navigation Infrastructure – making use of space-based navigation aids (satellites), ground-based aids (beacons) or other systems that can aid navigation.

Existing Cape Town Terminal Airspace

Standard Instrument Departures (SIDs): SIDs are standardized departure procedures designed to ensure the safe and efficient flow of departing aircraft from the airport's airspace. They provide a structured path for aircraft to follow immediately after take-off, guiding them from the runway to the en-route phase of their flight. SIDs typically include altitude and heading restrictions to keep departing aircraft separated and organized as they transition from the airport area to the larger airspace system. For Cape Town International Airport, the SIDs include procedures that help aircraft navigate out of the busy terminal airspace while avoiding conflicts with other departing and arriving traffic. These procedures could involve specific climb gradients, waypoints, and altitude restrictions to ensure safe separation and efficient traffic flow.

Standard Terminal Arrival Routes (STARs): STARs are standardized arrival procedures that guide aircraft from the en-route phase of their flight to the terminal airspace of an airport. They provide a structured and predictable path for arriving aircraft, allowing air traffic controllers to efficiently manage the flow of traffic as aircraft approach the airport. For Cape Town International Airport, STARs include designated routes, waypoints, altitude and speed restrictions, and other instructions that help arriving aircraft transition from the larger airspace system to the terminal airspace in a safe and organized manner. STARs help prevent congestion and ensure a smooth flow of traffic during the arrival phase.

Current CTIA Airport Capacity

The current CTIA runway capacity declaration is 30 aircraft per hour. This volume of runway traffic is managed to and from the runway by means of a single STAR and / or SID bot both runways 01 and 19 .

To increase capacity, Point Merge Design Methodology and Wake Turbulence Re-categorisation, or Wake RECAT, may be implemented in the (near) future.

Industry Consultation

Preliminary stakeholder engagements were conducted to gather information and feedback on the proposed Airspace CONOPS as it was being developed

Point Merge: Point Merge design principles for air traffic control flight procedures will be implemented. Point Merge is a systemized method for sequencing arrival flows used at various airports globally. It was developed by the EUROCONTROL Experimental Centre (EEC) in 2006. Point Merge is an air traffic management system with the following key features:

1. Standardizing Arrival Routes for incoming aircraft, reducing holding patterns.
2. Includes continuous descents for fuel and emission savings.
3. Sequencing and Separation ensure orderly and safe arrivals, reducing controller interventions.
4. Predefined routes enhance arrival predictability, aiding capacity management and reducing delays.
5. Designed with redundancy and fail-safes for safe operations.
6. Adaptable to airport-specific needs.

Point Merge optimizes arrival operations by reducing fuel consumption, emissions, and noise while increasing airport efficiency and capacity during peak traffic times. A 2020 study showed a reduction of 2,9% in flight time, 25,1% in fuel burn and 16,1% reduction in average pollution where point merge methodology is implemented. Point Merge was first implemented at Oslo (2011) and thereafter at Dublin (2012), Point Merge is now operational for 38 airports through 19 countries and 4 continents, such as Istanbul, Shanghai, Tokyo, Mexico or Sao Paulo.

RECAT: The existing International Civil Aviation Organisation (ICAO) wake vortex separation rules are based solely upon aircraft weight, categorised as Heavy, Medium or Light. While safe, in some respects, they are now outdated and lead to over-separation in many instances. The first implementation of RECAT separation standards, based on the FAA RECAT 1.5 scheme, occurred in the United States at Memphis, Tennessee in November 2012. Since, all major US TRACON facilities have transitioned to RECAT. The first European implementation of the RECAT-EU separation standards occurred at Paris in 2016. Since, it is already in daily operations at Paris CDG, London Heathrow (since 2018), Vienna (since February 2020), and Barcelona / LEBL (since May 2022). Immediate benefits, in terms of runway capacity and operational efficiencies, will result from implementation of RECAT protocols. These benefits include:

1. Peak period runway throughput can increase by 5% or more depending on airport traffic mix.
2. For an equivalent volume of traffic, RECAT spacing results in a reduction of the overall flight time for each affected aircraft reducing fuel burn, emissions and operating costs.
3. Due to more efficient departure and arrival spacing, RECAT allows a more rapid recovery from adverse conditions or a runway change.

Point Merge and RECAT Implementation can potentially add around 10% capacity to an airport. However, in this CONOPS it is expected that, for the time being, the sequencing of arrival flows in the Cape Town Terminal Airspace will still be based on radar vectoring and that the conventional wake turbulence criteria will remain in use.

Industry Consultation

Preliminary stakeholder engagements were conducted to gather information and feedback on the proposed Airspace CONOPS as it was being developed

Continuous Descend Operations and Continuous Climb Operations

The airspace route network should support Continuous Descend Operations and Continuous Climb Operations (CDO/CCO) to enable fuel savings and carbon emission reductions. Routes in and out of the Cape Town terminal airspace (TMA) should be optimized for dual parallel inbound and outbound streams to support a variety of aircraft performance criteria and CCO/CDO at the same time. PBN permits point-to-point flight without the need to navigate along terrestrial en-route navigation aids like VORs and NDBs.

Performance-Based Navigation Implementation

Performance Based Navigation (PBN) is a cornerstone of modern navigation, providing precise and efficient navigation procedures based on aircraft performance capabilities. The following Navigation Specification is anticipated and will be observed for FAWN.

	Navigation Specification for Cape Winelands Airport
RNP – onboard performance monitoring and alerting	Terminal and Enroute Procedures
	RNP 1 RNP 0.3 RNP APCH RNP AR APCH
RNAV – No Onboard performance and monitoring and alerting.	En-Route Procedures
	RNAV 1 / 2 / 5

Note: RNP AR – Authorisation required means the crew must be trained (authorised) to fly the procedure. RNP 0.3 is mainly for helicopter operations (PinS), an example is to fly to a helipad on the roof of the nearest hospital in IMC.

PBN Implementation at CWA

The implementation of PBN at Cape Winelands Airport involves:

1. Consultation with local operators that will use the airport to ensure their aircraft are suitably equipped and the crews are trained in modern navigation techniques.
2. Consultation with ATNS to ensure dual parallel arrival and dual parallel departure routes so that neither traffic for any of the two airports are constrained by a singular in-trail stream.
3. Terrain and obstacles assessment to determine optimized routes and arrival / departure procedures.
4. Consultation with expert flight procedure designers to ensure systemization of the SIDs and STARS i.e., vertical splits at appropriate distances and altitudes to ensure fuel efficient procedures.
5. Close STAR operations that are compatible with CDO and ATFM flow measures i.e., 4D timed arrivals.
6. Routes shaped for maximum noise abatement in the vicinity of the aerodrome so that local communities and farming is not unduly affected by aircraft noise, especially at night.
7. VFR lanes and VRP (Visual Reporting Points) that are established in the Winelands CTR that are deemed separated from IFR arrivals and departures. These VRPs become essential in IMC conditions when SVFR flights are separated from IFR and other SVFR flights.
8. Transit routes for VFR and military flights that pass below the ILS or Baro-VNAV approach paths. This will be particularly helpful in accommodating the general aviation community that will make use of the airport.

Industry Consultation

Preliminary stakeholder engagements were conducted to gather information and feedback on the proposed Airspace CONOPS as it was being developed

9. PinS (Point-in-Space) routes for helicopter operations with both a visual and an instrument segment that are clear of IFR arrival and departure tracks. These are used in both VMC and IMC to facilitate uninterrupted helicopter operations from FAWN.

Note: Most of these procedures described above will require RNP Specifications to be developed.

RNAV (Area Navigation)

Developing Required Navigation Performance (RNP) and Area Navigation (RNAV) procedures for both en-route and terminal phases. RNAV procedures offer flexible routing options, optimizing airspace utilization and minimizing aircraft fuel consumption and carbon emission reductions. Dual parallel route structures should accommodate the full spectrum of performance traffic while optimising capacity utilization.

RNP Approach Procedures

Designing RNP approach procedures, such as RNP AR (Authorization Required) or RNP APCH (Approach) to improve approach accuracy, enable steeper approach angles, and reduce noise in densely populated areas. A range of other 3D approach procedures will also be developed that will meet the needs of a variety of operators and the fleet of aircraft that they are operating.

Note: RNP AR (Authorization Required) procedures are advanced procedures that are typically used at airports in mountainous terrain that are difficult to reach using conventional procedures. From a design perspective, the main advantages of an RNP AR APCH procedure are that they enable turns in the final approach and that the protection areas can be reduced by prescribing an RNP value. For the operator, this should lead to lower minima and/or improved flyability. These advantages come at a cost. RNP AR procedures impose additional requirements related to aircraft certification, operator approval and flight crew qualification and training. The cost-benefit should be carefully analyzed when considering such a procedure at CWA.

Vertical Navigation (VNAV) Procedures

Incorporating VNAV procedures for precise descent profiles, aiding noise abatement and reducing environmental impact during approach and landing. The main advantage of vertical guidance is the ability to develop 3-D approaches i.e. approaches with vertical guidance like a precision approach typically has. Guided Visual Approaches are an excellent example of 3-D navigation where the vertical guidance is provided by the aircraft's Baro-VNAV system (altimeter). The use of 3-D VGAs is envisaged to bring about major fuel savings and efficiencies for operators at Winelands in VMC conditions. LNAV/VNAV procedures bring significant benefits without the cost of infrastructure as only RAIM is required.

Industry Consultation

Assurance of Harmonious Operational Coexistence: CWA, CTIA and surrounding airports

With a profound understanding of the pivotal role that airports play in the connectivity and mobility of modern society, we prioritize the harmonious coexistence between aviation activities and the community at CTIA and surrounding airports. Rooted in transparency, collaboration, and a deep sense of responsibility, our commitment strives to ensure that the airport's operations flourish hand in hand with the well-being and tranquillity of the surrounding environment.

When appropriate air traffic management is implemented between two or more airports, they can operate independently while ensuring safe and efficient air traffic flow. This is achieved through coordinated communication, data sharing, and adherence to established procedures. At a strategic level, by means of defined design criteria to be observed at flight procedure design stage, pre-tactically by means of demand and capacity balancing and tactically by means of well-developed Letters of Procedure between the operational units.

Defining Terms of Reference

1. The design principles will ensure a harmonious coexistence between these airports, ensuring the smooth functioning of CWA, CTIA and surrounding airports. It is foreseen that the future airspace model will in fact increase the capacity for some surrounding airports.
2. To address potential concerns, a comprehensive airspace management design that will carefully segregate or integrate is proposed, whichever aligns with the design principles, the flight paths and air traffic patterns of the two airports. This system will be designed to ensure that any potential conflicts or overlaps are minimized, promoting the safety and efficiency of operations at both locations, while at all times considering the impact of relevant obstacles and design criteria.

3. Additionally, our commitment to effective communication and collaboration between CWA and surrounding airports will play a pivotal role in maintaining a cohesive airspace environment. Regular coordination meetings, data sharing, and open dialogue between the authorities of both airports will help us address any challenges swiftly and ensure that our airspace remains well-organized and secure.
4. We are committed to fostering a positive relationship with all the communities and stakeholders that serve the surrounding airports and we believe that by working together, we can create an aviation landscape that benefits everyone.

Proactively addressing concerns about the interaction between CWA operations and surrounding airports will ensure their harmonious coexistence. An intricate airspace management design will segregate or integrate flight paths, ensuring safety and efficiency while accommodating obstacles. Communication and collaboration between the airports will play a crucial role, with coordination meetings and data exchange enhancing airspace cohesion. Encouraging stakeholder engagement, the commitment is to build a positive relationship and a collaborative aviation landscape benefiting all parties involved.

Current Situation

Airspace

Airspace

Current Airspace setup

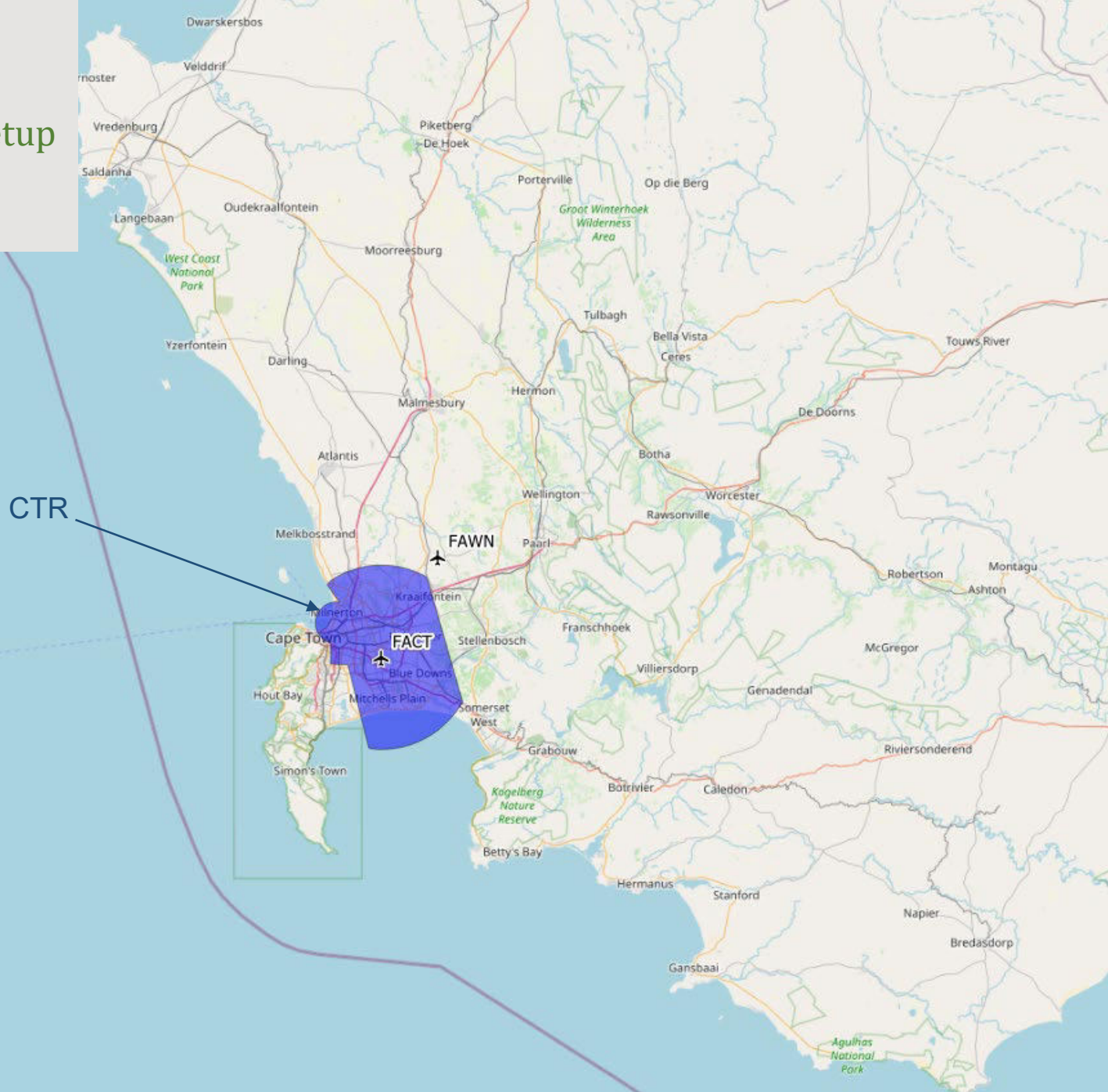

Airspace build up

CTR
GND – 2500FT ALT

CTR

FACT

FAWN

Airspace

Current Airspace setup

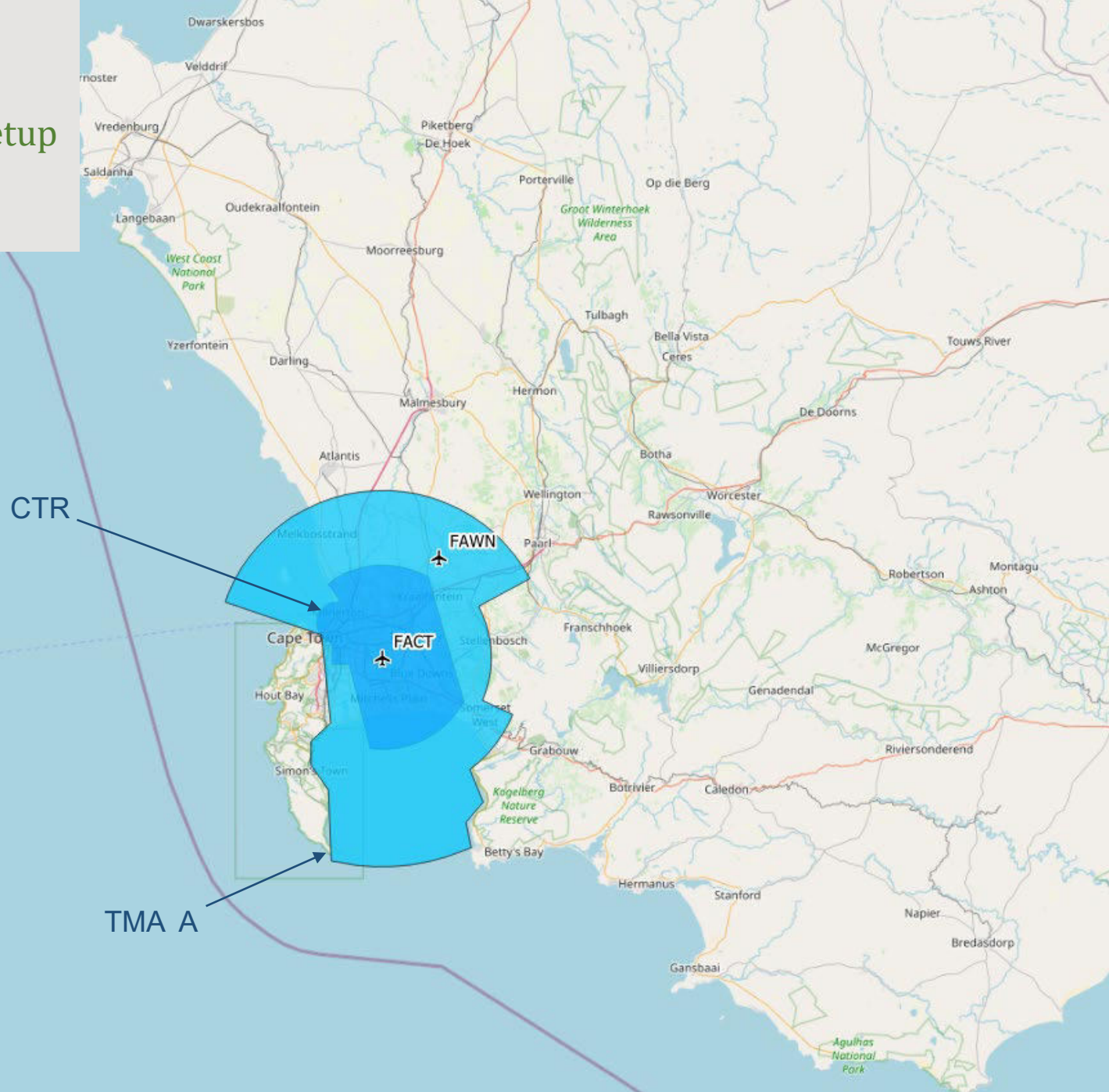

Airspace build up

CTR
GND – 2500FT ALT

TMA A
2500FT ALT – FL085

TMA A

CTR

FACT

FAWN

Airspace

Current Airspace setup

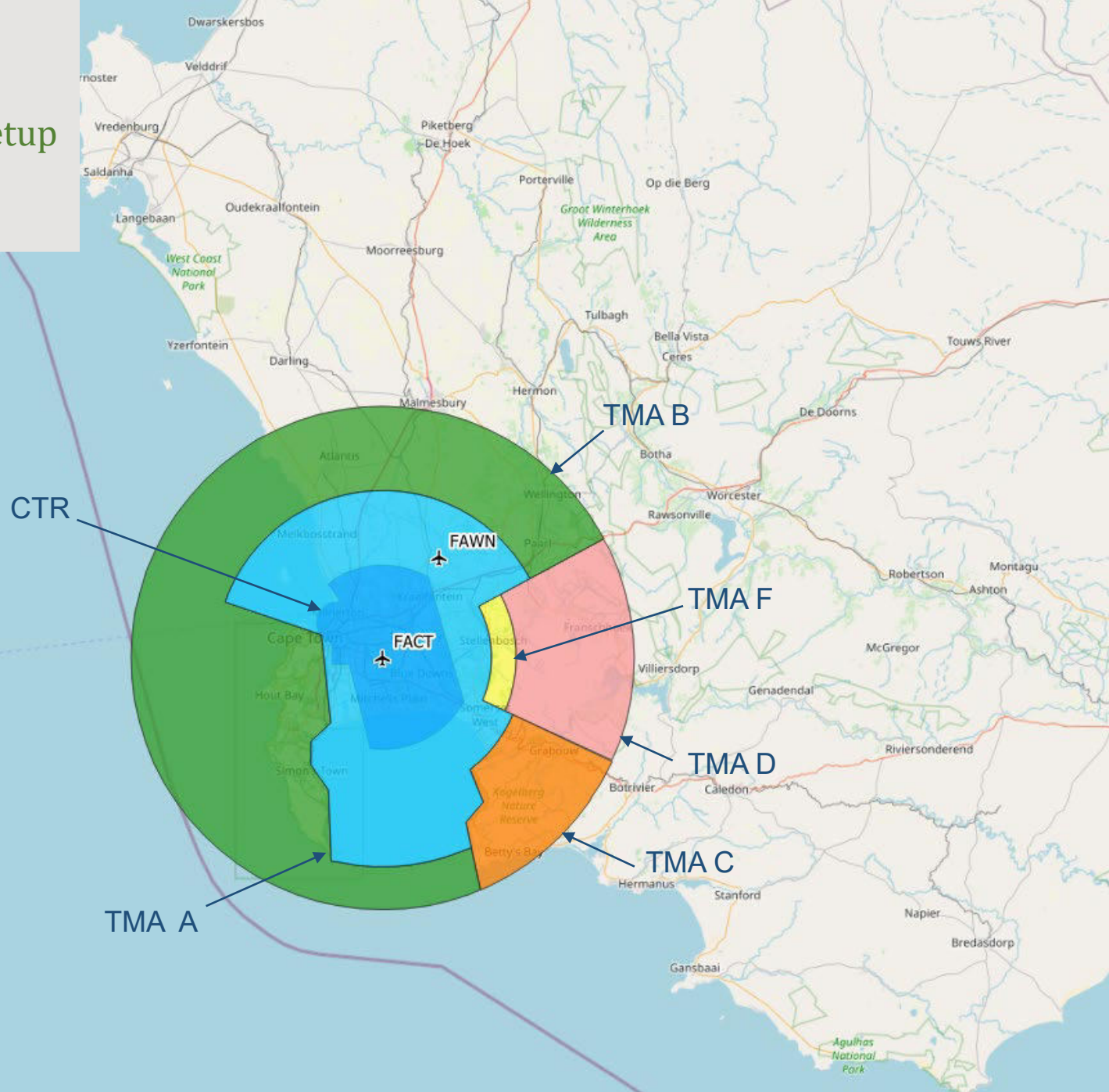

Airspace build up

CTR
GND – 2500FT ALT

TMA A
2500FT ALT – FL085

TMA B
4500FT ALT – FL085

TMA C
5500FT ALT – FL085

TMA D
7500FT ALT – FL085

TMA F
4500FT ALT – FL085

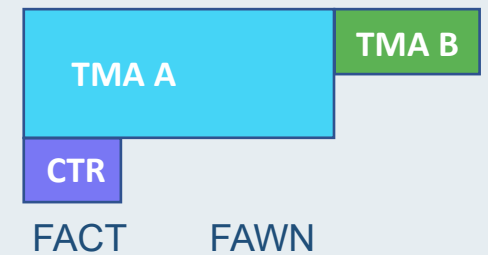

Airspace

Current Airspace setup

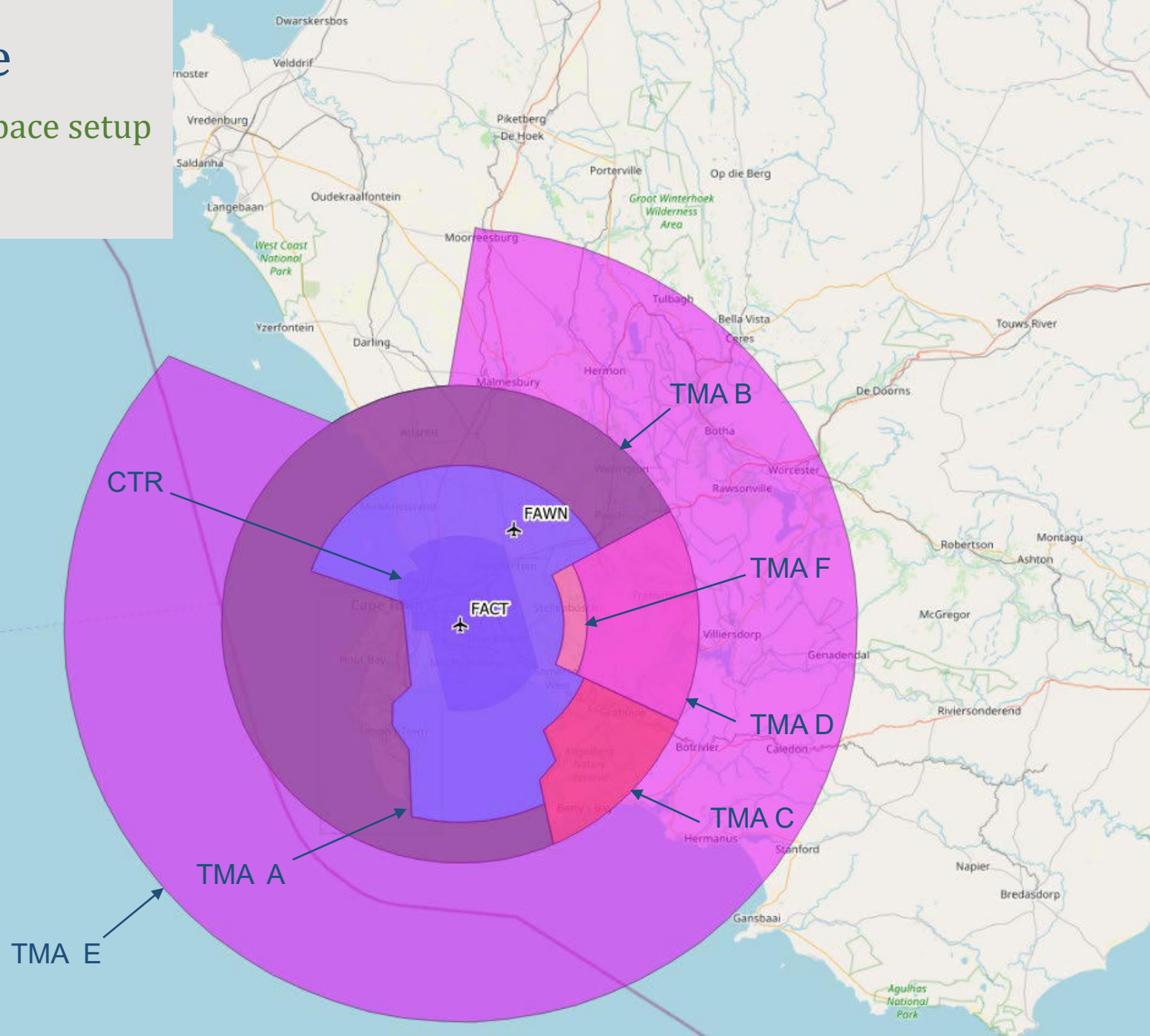

Airspace build up

CTR
GND – 2500FT ALT

TMA A
2500FT ALT – FL085

TMA B
4500FT ALT – FL085

TMA C
5500FT ALT – FL085

TMA D
7500FT ALT – FL085

TMA E
FL085 – FL145

TMA F
4500FT ALT – FL085

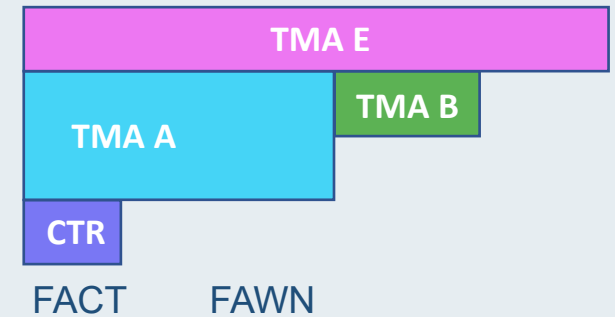

Airspace

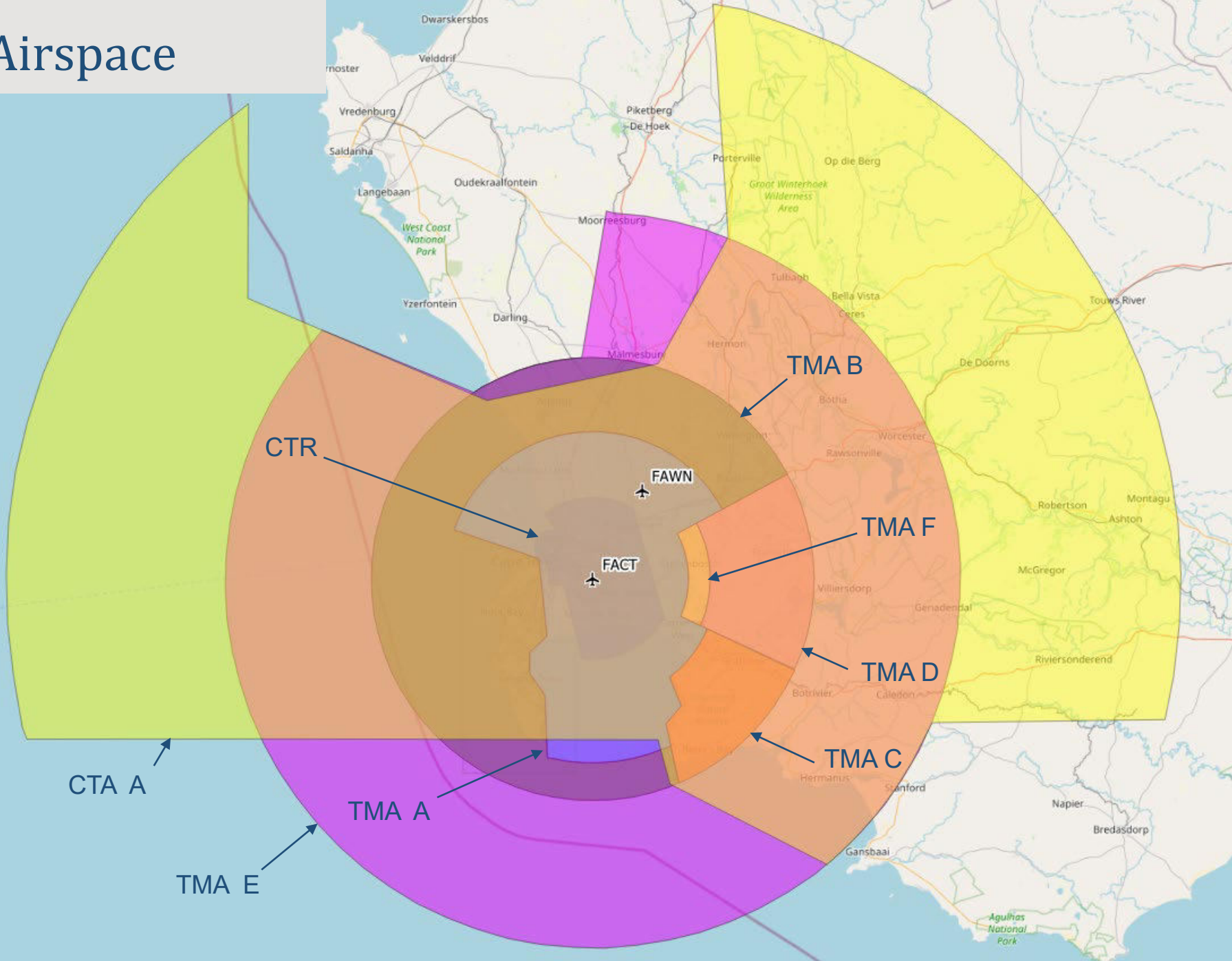

Airspace build up

- CTR
GND – 2500FT ALT
- TMA A
2500FT ALT – FL085
- TMA B
4500FT ALT – FL085
- TMA C
5500FT ALT – FL085
- TMA D
7500FT ALT – FL085
- TMA E
FL085 – FL145
- TMA F
4500FT ALT – FL085
- CTA A
FL145 – FL195

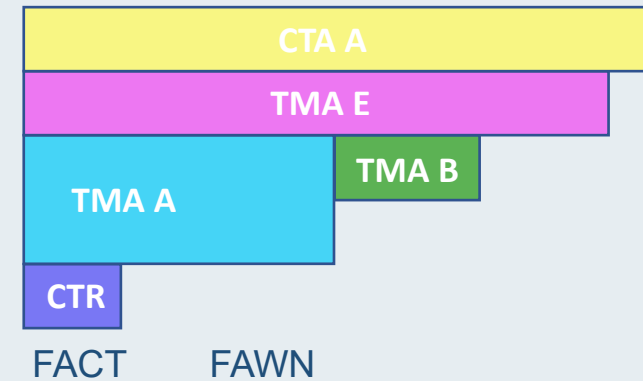

Airspace

Current Airspace setup

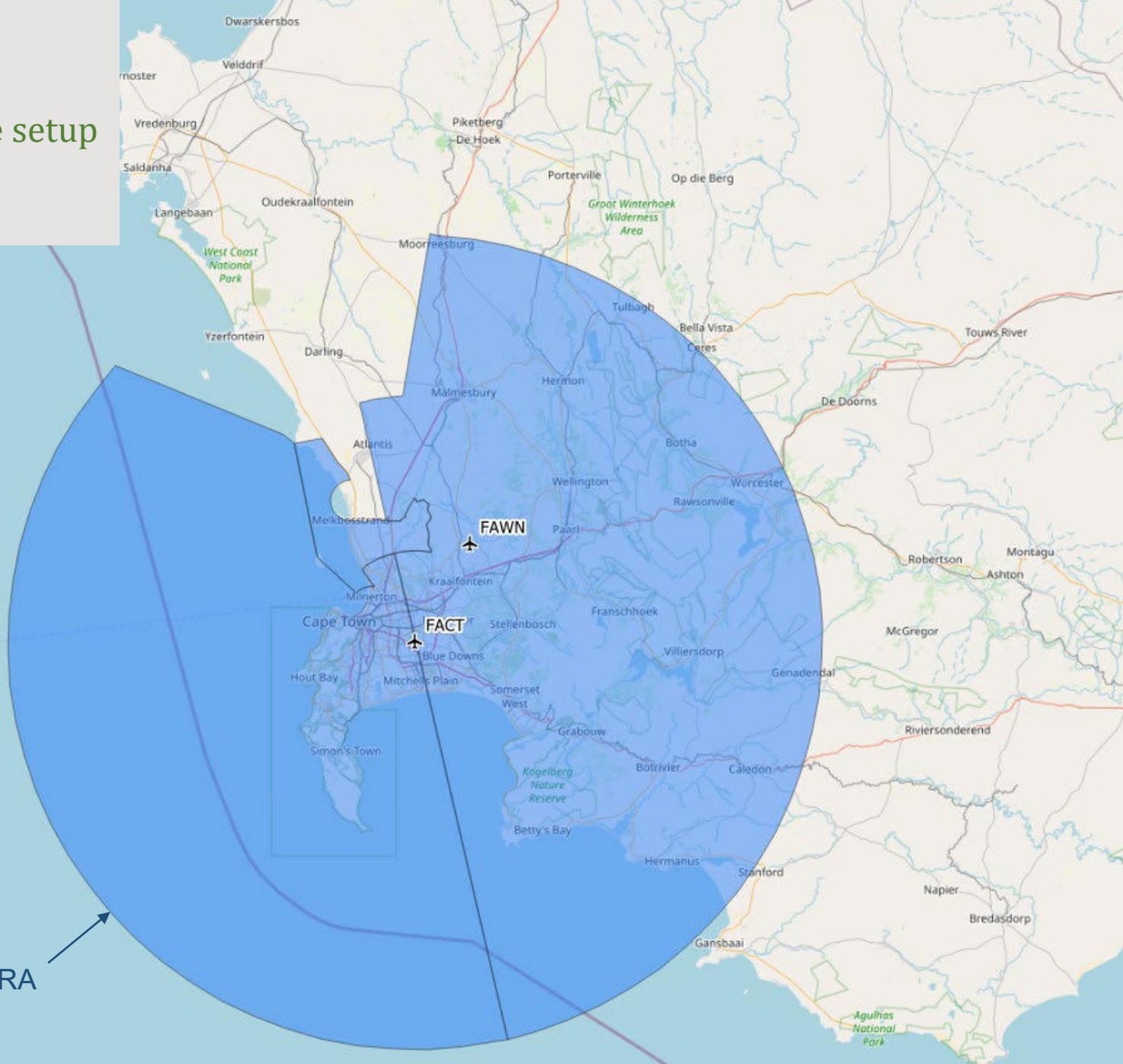

Cape Town SRA

Airspace build up

Cape Town SRA

The airspace below the Cape Town TMA, excluding all promulgated controlled airspace, FADs, FARs and FAPs, is declared as a Special Rules Area and will be known as the CAPE TOWN SPECIAL RULES AREA (SRA). The Cape Town SRA shall comprise of three sectors divided as follows:

- Northern SRA Sector: 126.8MHz
- Western SRA Sector: 125.8MHz
- Eastern SRA Sector: 124.8MHz

RULES APPLICABLE WITHIN THE CAPE TOWN SPECIAL RULES AREA

- Avoid controlled airspace unless otherwise authorised by Air Traffic Control.
- Comply with the Traffic Information Broadcast by Aircraft (TIBA.)
- The Cape Town Special Rules Area shall exclude all promulgated controlled airspace and FADs, FARs, FAPs.
- Flights must be conducted at an indicated airspeed not exceeding 180 knots.
- It is recommended that where possible aircraft have their landing lights switched on.
- Aircraft operating within the special rules area below FACT TMA A must not exceed 2000FT ALT.

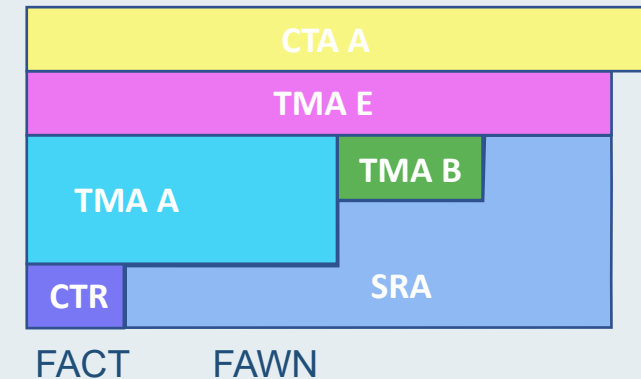

Airspace

Prohibited, Danger & Restricted Areas

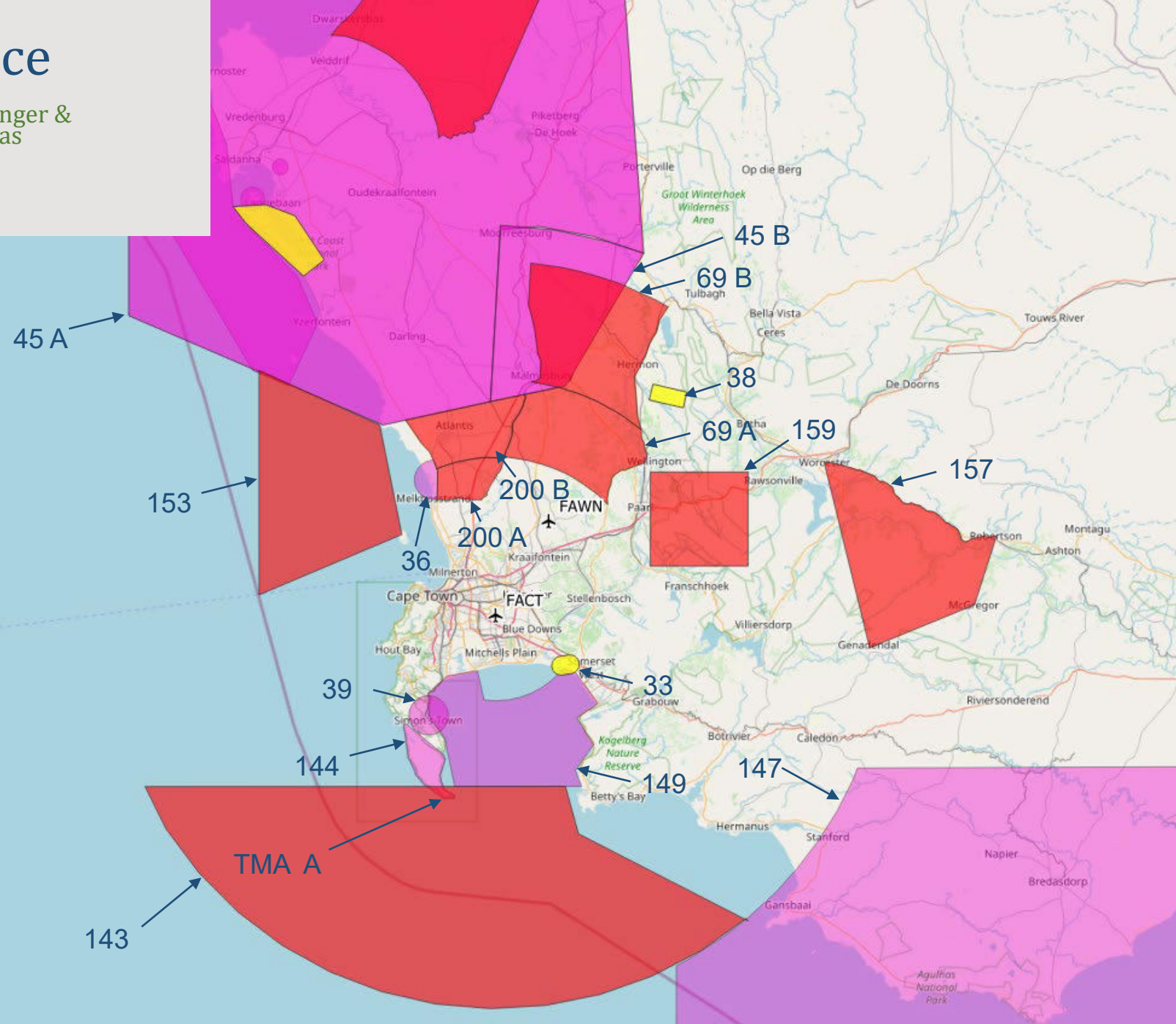

Prohibited Areas

33 - Firgrove
GND – 1500FT AGL

38 - Krantzkop
GND – 2000FT AGL

Danger Areas

46 – FALW Military Low Flying Area
GND – 1500FT

69 – Stellenbosch Flying Training Area
Area “A” GND – 4000ft
Area “B” GND – 8000ft

143 – West Cape Fleet Training Area
GND – FL195

153 – Cape Town Maritime Flying Training Area
GND – 2000FT ALT

157 – Worcester/Robertson general Flying Area
GND – FL070

159 – Ysterplaat MIL Helicopter Mountain Flying Area
GND – 1000FT AGL

200 – Cape Town Flying Area
Area “A” 1500FT AGL – FL195
Area “B” FL120 – FL195

Restricted Areas

36 – Koeberg Nuclear Power Station
GND – 2000FT AGL

39 – Simonstown
GND – 1500FT ALT

45 – Langebaanweg Military Flying Area
Area “A” GND – 2000FT ALT
Area “B” GND – 4000FT ALT

144 – Cape of Good Hope Nature Reserve
GND – 2000FT ALT

147 – Overberg
GND – FL195

149 – Vals Bay
GND – 2500FT ALT

Airspace

NEMPA

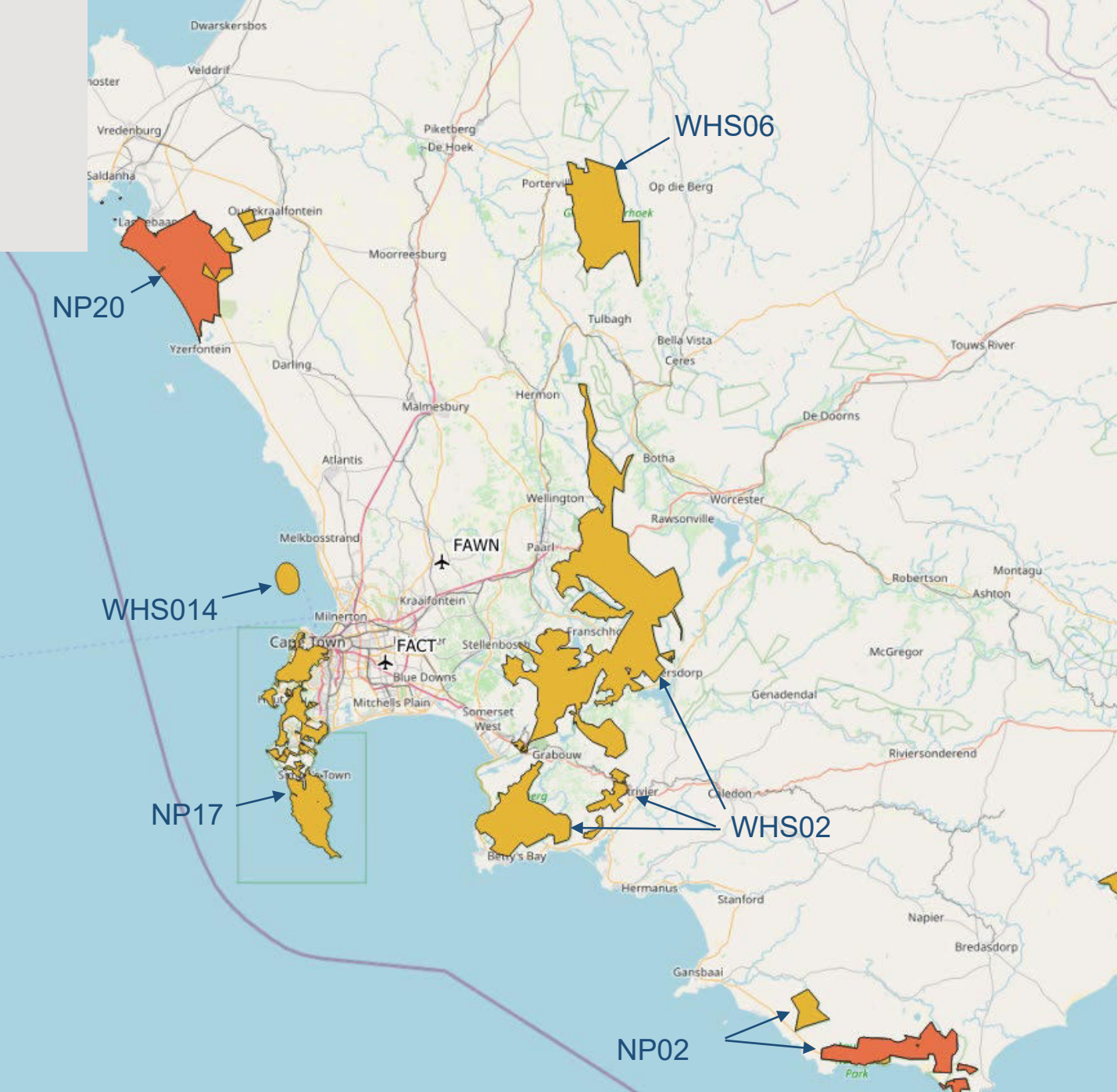

FLIGHT RESTRICTIONS OVER NATIONAL PARKS AND WORLD HERITAGE SITES

National Parks

NP02 - Agulhas National Park
3520FT MNM ALT

NP17 - Table Mountain National Park
6070FT MNM ALT

NP20 - West Coast National Park
3140FT MNM ALT

World Heritage Sites

WWS02 – Boland Mountain Complex
8980FT MNM ALT

WWS06 – Groot Winterhoek Wilderness Area
9100FT MNM ALT

WWS014 – Robben Island
2540FT MNM ALT

Terrain and Obstacles

Terrain Data

ASTER GDEM

No terrain data is available from the Client or from SACAA. Therefore, ASTER (Advanced Spaceborne Thermal Emission and Reflection Radiometer) GDEM (Global Digital Elevation Model) was used instead.

This data is publicly available through NASA's Earthdata service ([New Version of the ASTER GDEM | Earthdata \(nasa.gov\)](https://earthdata.nasa.gov/)).

Indicated areas with high terrain are of particular interest for the flight procedures in and out of FAWN.

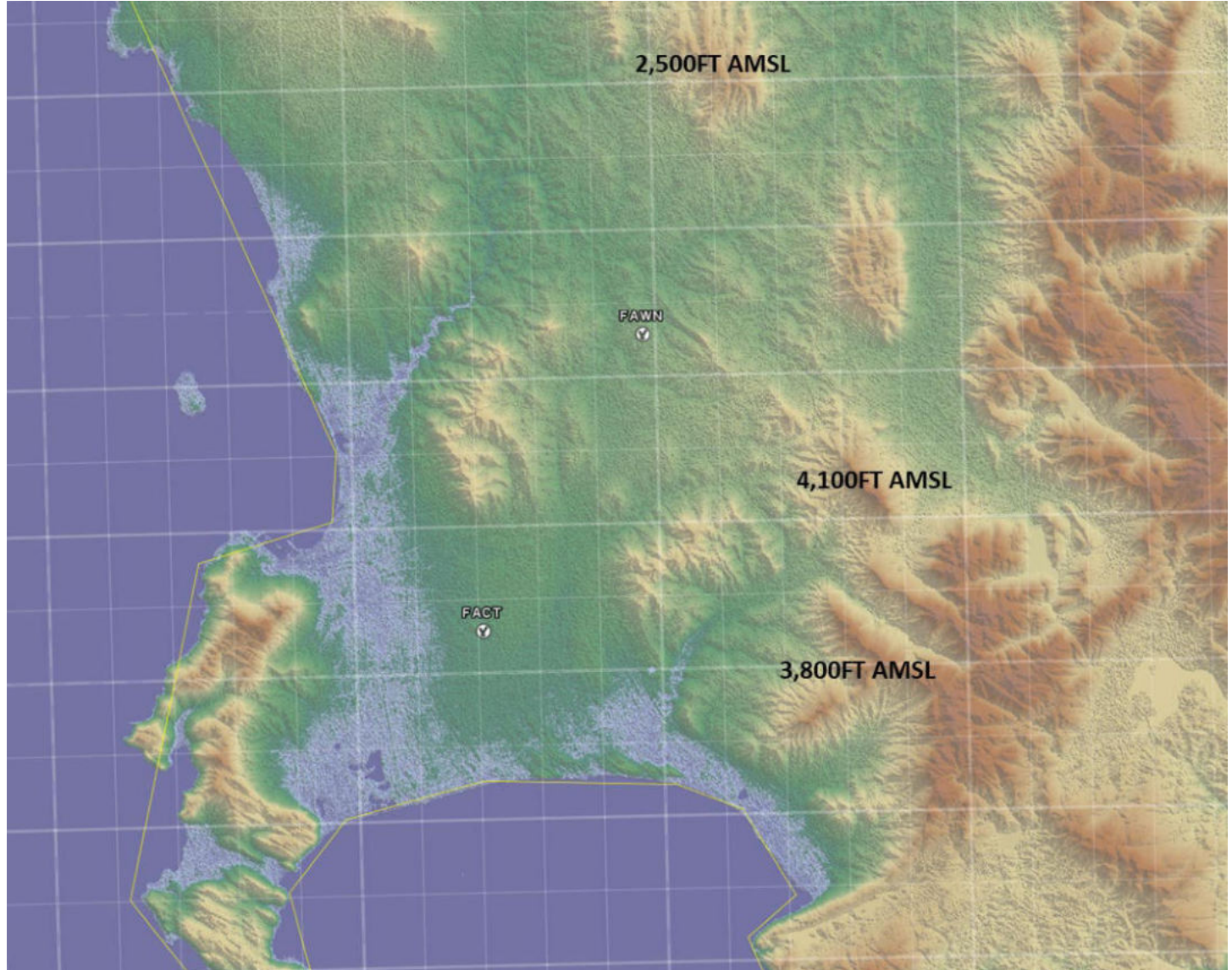

ASTER Digital Elevation Model (DEM) terrain in the vicinity of FAWN and FACT with high terrain areas indicated

Obstacle Limitation Surfaces

A WGS-84 Survey was carried out to identify any obstacles penetrating the Obstacle Limitation Surfaces of the airport as defined by ICAO Annex 14

ATNS conducted an initial WGS84 survey on the Cape Winelands Airport. We present here a summary of some of the results of the ICAO Annex 14 Obstacle Assessment for Cape Winelands Airport.

An **obstacle** is defined as:

- Any object that stands on, or stands above, the specified surface of an obstacle restriction area which comprises the runway strips, runway end safety areas, clearways and taxiway strips; and.
- Any object that penetrates the ICAO Annex 14 Obstacle Limitation Surfaces (OLS), a series of surfaces that set the height limits of objects, around an aerodrome.
- Runway 01/19 was surveyed and OLS were defined for Precision Approach Runway.
- Runway 14/32 was surveyed and OLS were defined for Non-instrument Runway.

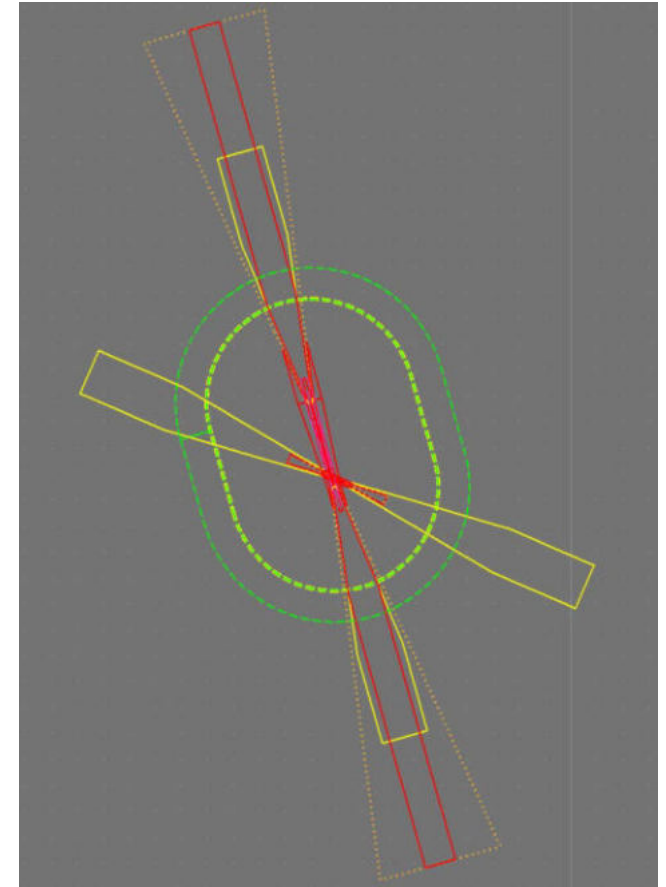

Annex 14 obstacle limitation surfaces (OLS) at Cape Winelands Airport

Obstacles Identified

The OLS Report, dated 04 October 2022, highlight a total of 69 obstacles which penetrate the Annex 14 surfaces.

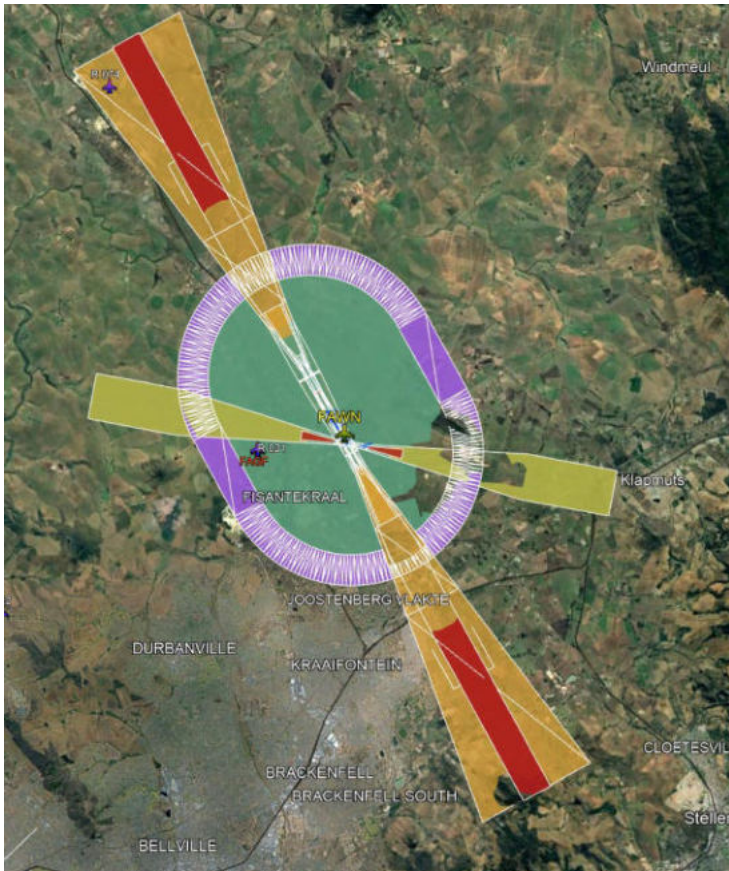

Obstacles penetrating the OLS surfaces

- 1 Balked Landing obstacle for RWY01
- 2 Inner transitional obstacles for RWY01
- 16 Strip obstacles for RWY01-19
- 8 Transitional obstacles for RWY01
- 2 Balked landing obstacles for RWY19
- 1 TOFPA obstacle for RWY19
- 8 Transitional obstacles for RWY19
- 3 Take-off climb obstacles for RWY14
- 7 TOFPA obstacles for RWY14
- 1 Strip obstacle for RWY14-32
- 3 Transitional obstacles for RWY14
- 5 Transitional obstacles for RWY32
- 8 Inner horizontal obstacles for FAWN
- 3 Conical obstacles for FAWN

Aerodromes

Aerodromes

Aerodromes in the vicinity

Near Cape Town multiple airports, airstrips and heliports can be found. For a complete overview refer to the baseline report (or Appendix). Most of the listed aerodromes are small aerodromes (gravel airstrips from local farmers) which will operate very locally at lower altitudes within uncontrolled airspace and the number of movements is likely to be very limited. It is expected that the air traffic from following aerodromes could potentially interact with the foreseen air traffic at FAWN:

- **Cape Town International Airport (FACT)**
IFR and VFR traffic
- **Stellenbosch (FASH)**
VFR traffic only
- **Ysterplaat (FAYP)**
Military traffic
- **Morningstar Airfield (ZA-0120)**
VFR traffic only

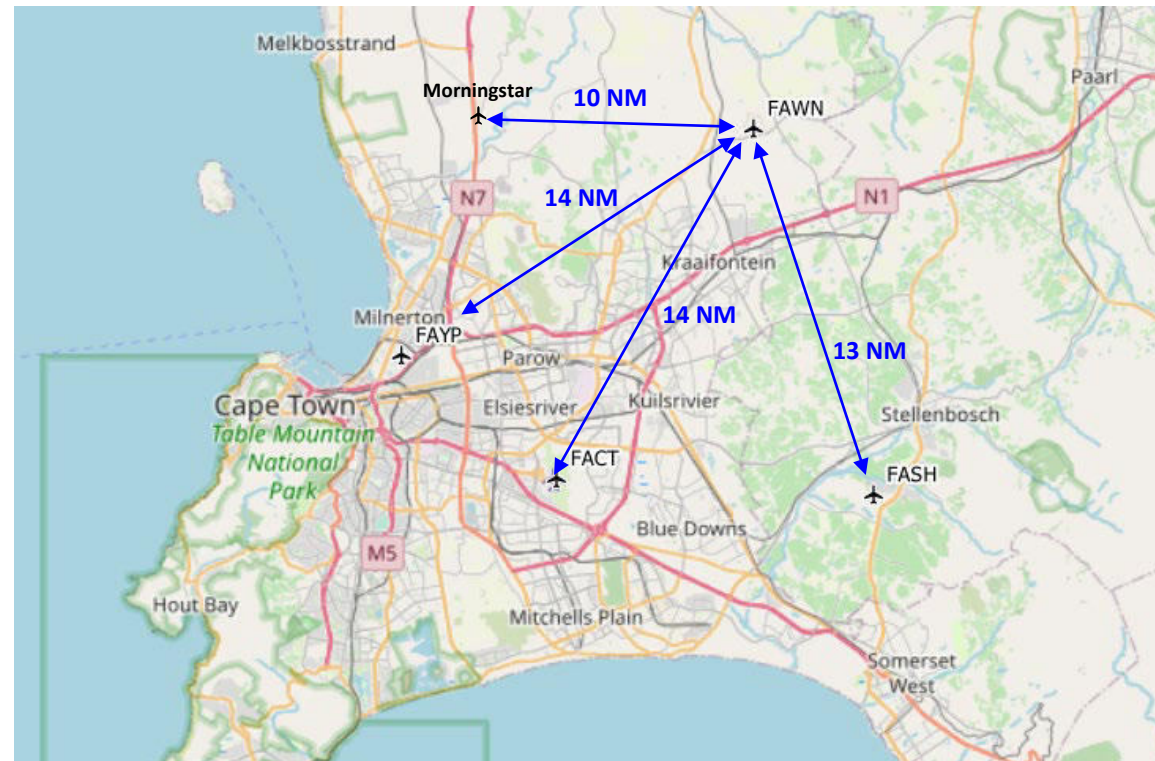

FAWN

Cape Winelands

CWA currently serves as a general flying airfield and is a favorite for flight training in the Cape Town area. In addition, the airfield offers aircraft maintenance, limited private charter flights, and hangarage. Aviation gasoline (Avgas 100LL) is also sold on site from a 28,000L containerised tank.

There exists four concrete strips of which are 90m width, but vary in lengths between 700m and 1500m, each with unique designations depending on the magnetic bearing of each strip in degrees, i.e., 01/19, 05/23, 14/32 and 03/21 degrees. Runways 01/19 and 03/21 are currently not in use. Runway 05/23 and 14/32 are currently in use for VFR traffic only. The main characteristics are provided in the table.



RWY NR [-]	Dimensions [m]	Surface [-]
05/23	900 x 20	Concrete
14/32	700 x 16	NIL



FACT

Cape Town International

Cape Town International Airport is the primary international airport serving the city of Cape Town. It is one of the busiest airports in South Africa. The airport handles international, regional and domestic flights.

The runway configuration consists out of one main runway 01/19 and one smaller cross runway 16/34.



RWY NR [-]	Dimensions [m]	Surface [-]
01/19	3201 x 61	Asphalt
16/34	1701 x 16	Asphalt

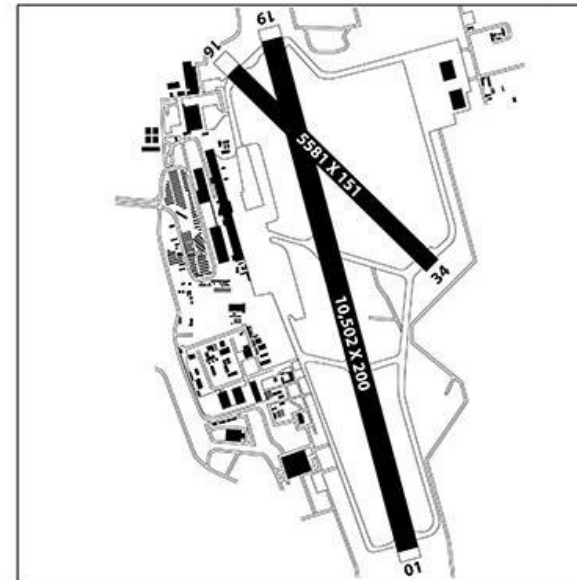

FASH

Stellenbosch

Aerodrome Stellenbosch is a small VFR airfield. It is used by light aircraft for recreational, training and fire and rescue operations.

Only one runway 01/19.



RWY NR [-]	Dimensions [m]	Surface [-]
01/19	760 x 16	Asphalt



FAYP

Ysterplaat

Is an Airforce Base used mostly for maritime patrol. No VFR or IFR procedures exist. Next to the military operation it can only be used in case of an emergency.

Only one main runway 02/20.



RWY NR [-]	Dimensions [m]	Surface [-]
02/20	1585 x 23	Asphalt

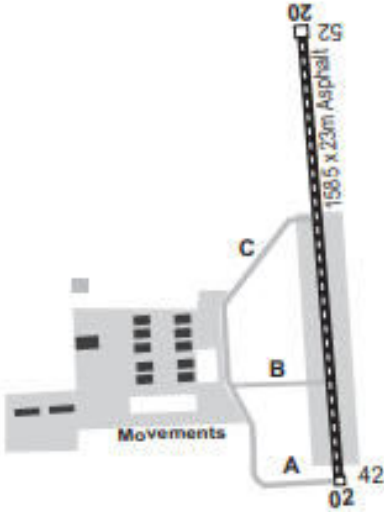

ZA-0120

Morningstar Airfield

Morningstar Airfield is a small VFR airfield located north of Cape Town along the West Coast. It is used by light aircraft for recreational, training and fire and rescue operations.

Only one runway 02/20.



RWY NR [-]	Dimensions [m]	Surface [-]
02/20	645 length	Asphalt

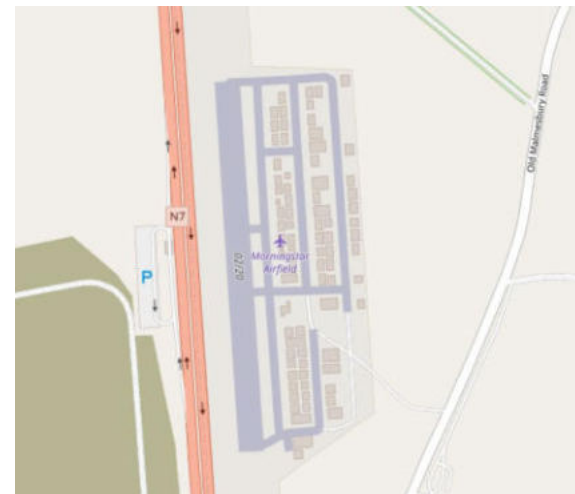

Radio Model Aircraft sites

Operations at the Radio Model Aircraft sites in the vicinity of FAWN are restricted to 400FT AGL, but Boland Model Aircraft Club occasionally operates at 1000FT AGL.



- Boland Model Aircraft
- Tygerberg Model Flying Club
- Hoogekraal Slope Site
- Cape Town Radio Heli Flyers
- Rondebossie Slope Site
- Kraaifontein RC Electric Park Flyers
- Swiss Flying Club
- Stellenbosch Model Aircraft Academy

FACT Operations

FACT - Operation

Update: AIRAC 1304

Procedures RWY 19

The following procedures are applicable for FACT towards or from RWY19.

- Standard Arrival Routes
 - ERDAS 1B
 - GETEN 1B
 - ASPIK 1B
 - EVUKI 1B
- Approaches
 - ILS Z
 - RNAV (GNSS)
 - RNAV (RNP) Z
 - VOR
- Standard Instrument Departures
 - TETAN 1A
 - TETAN 1B
 - IMSOM 1B
 - OKTED 1B
 - OKTED 1C

FACT - 19

Airfield NOTES: - Elev 151ft - Variation 25° W - Transition Altitude 7500ft - ILS 109.10 ; Course 189° - Approach 120.05 - Tower 118.1 - Ground 121.9
Max. Speeds & Levels: SID - Initial climb to FL090 - Advise RADAR (APP) of level passing for Mode C check STAR - Speeds indicated are MAX speeds - KIAS (inote IAS)

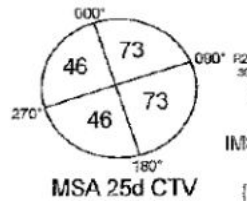

NOTES: - Not For Real World Aviation - Frequencies shown in MHz & kHz depending on facility - All DMIs from CTV unless otherwise indicated - Not to scale
CREATED BY MARTIN SMIT®

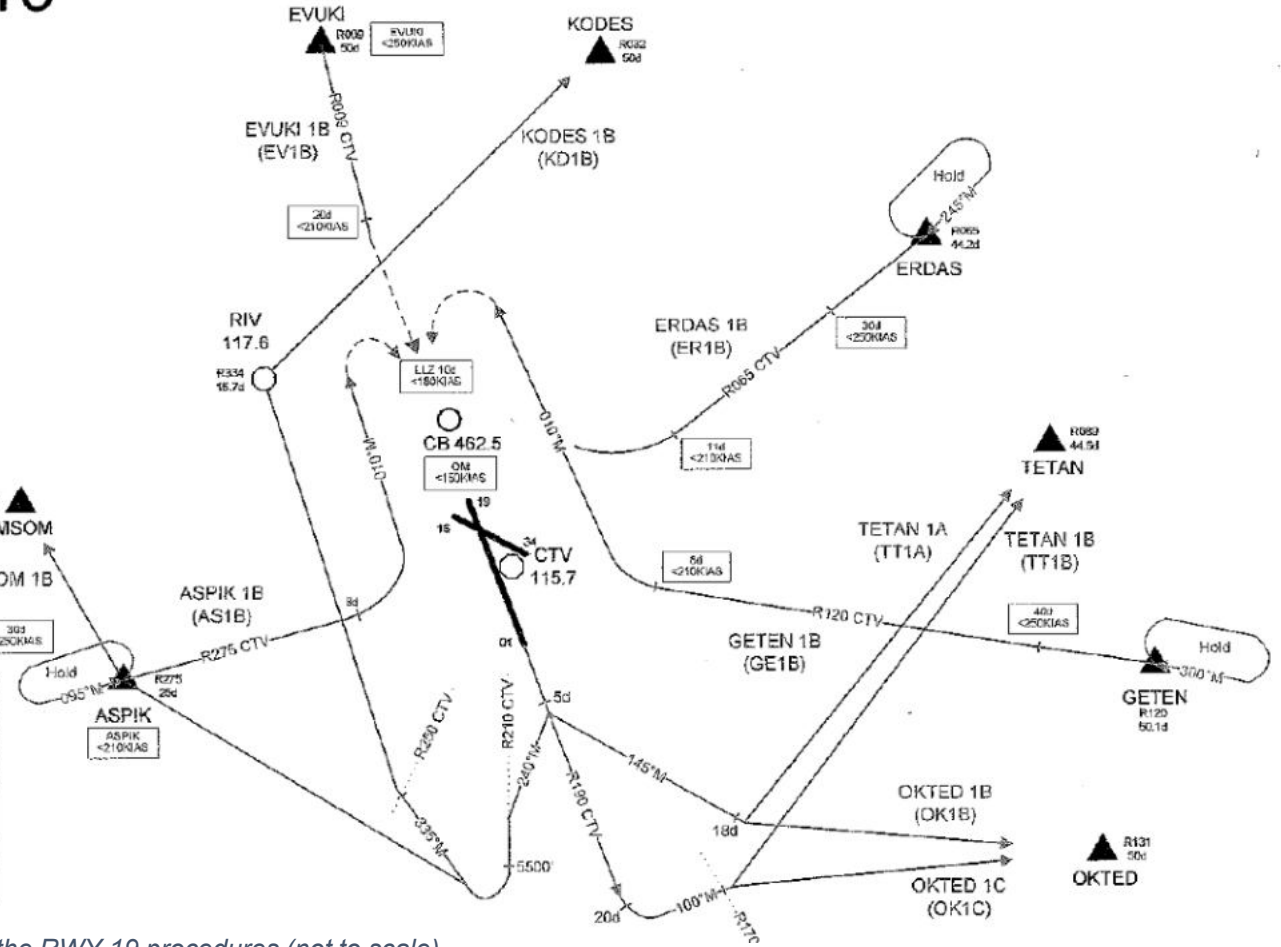

Schematic overview of the RWY 19 procedures (not to scale).

FACT - Operation

Update: AIRAC 1304

Procedures RWY 01

The following procedures are applicable for FACT towards or from RWY01.

- Standard Arrival Routes
 - ERDAS 1A
 - GETEN 1A
 - ASPIK 1A
- Approaches
 - ILS Z
 - RNAV (GNSS)
 - RNAV (RNP) Y
 - RNAV (RNP) Z
 - VOR Y
 - VOR Z
- Standard Instrument Departures
 - KODES 1A
 - IMSOM 1A

FACT - 01

Airfield NOTES:

- Elev 151ft
- Variation 25° W
- Transition Altitude 7500ft
- ILS 110.90 ; Course 009°
- Approach 120.05
- Tower 118.1
- Ground 121.9

Max. Speeds & Levels:

SID

- Initial climb to FL090
- Advise RADAR (APP) of level passing for Mode C check

STAR

- Speeds Indicated are MAX speeds
- KIAS (knots IAS)

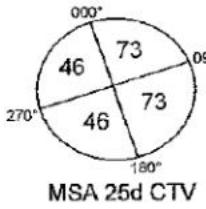

NOTES:

- Not For Real World Aviation
- Frequencies shown in MHz & kHz depending on facility
- All DMEs from CTV unless otherwise indicated
- Not to scale

CREATED BY MARTIN SMIT©

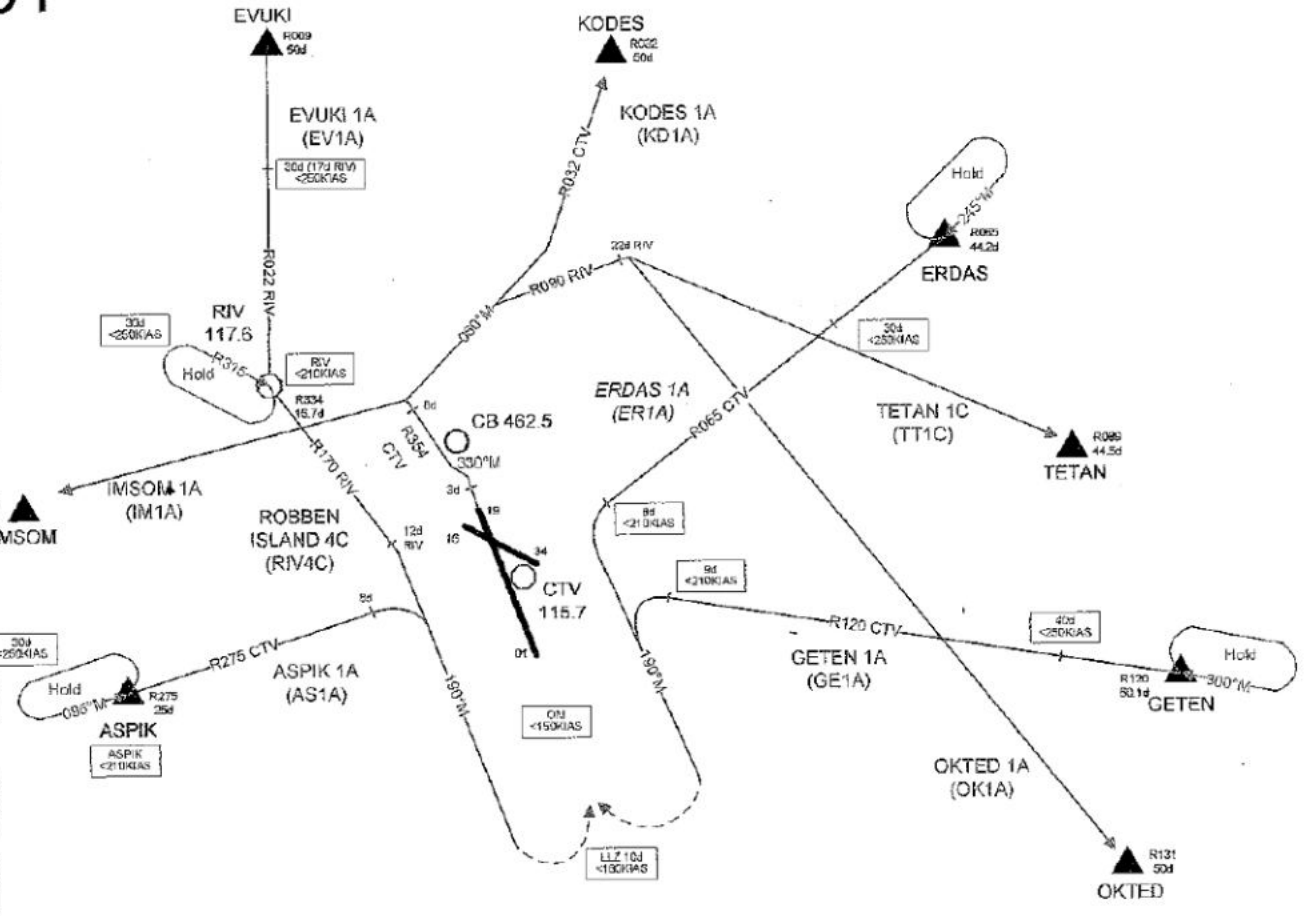

Schematic overview of the RWY 01 procedures (not to scale).

FACT - Operation

VFR operations

Standard VFR traffic routes and operations within Cape Town CTR (SA-AIP ENR 2.2) include:

1. Departures and Arrivals via:
 1. Kenilworth
 2. Bottleray hills
 3. Coastwise
2. Comply with the associated rules pertaining to VFR Traffic Routes.
3. NO VFR traffic may approach from the north of FACT.
4. The figure illustrate VFR traffic flow during runway 19 operation at Cape Town International Airport.
5. If and when the runway direction changes the routes also swop around to accommodate the traffic flows.

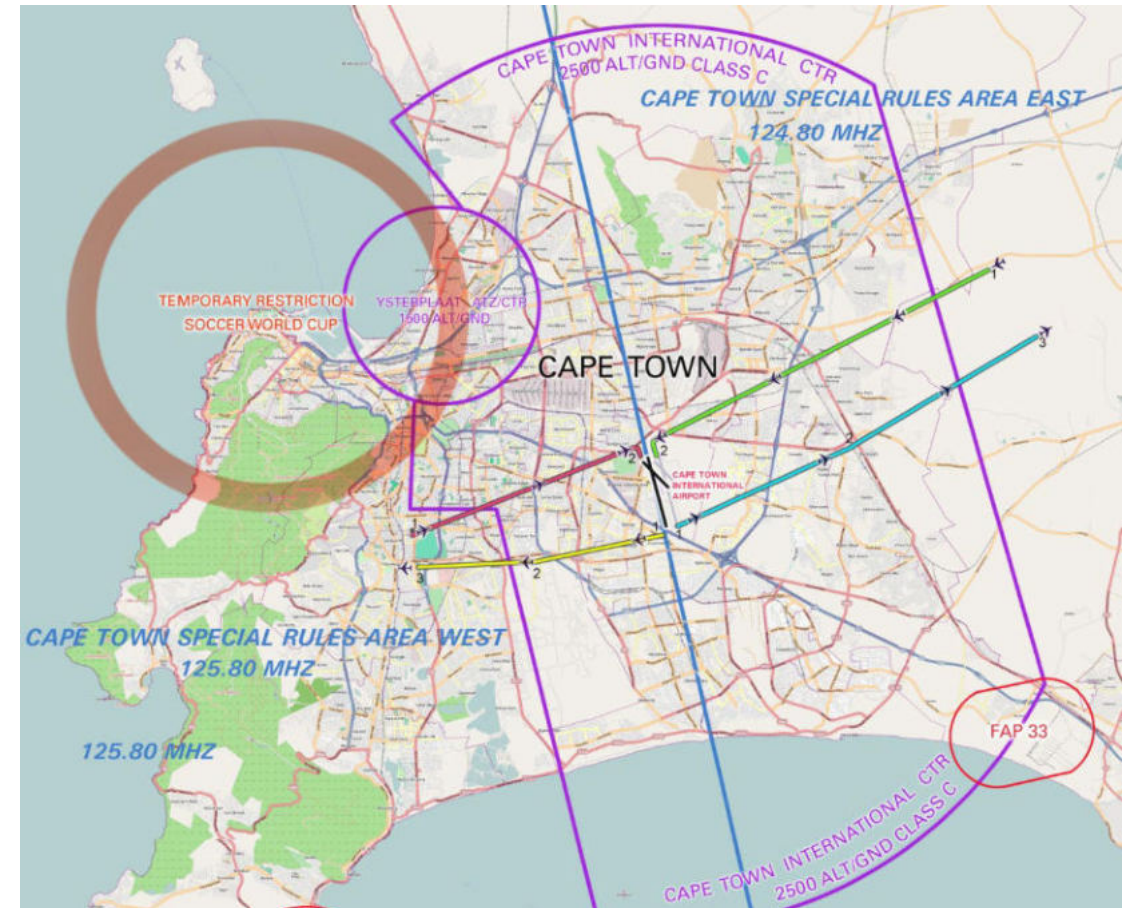

VFR traffic flows during operation of RWY 19 at FACT

FACT - Operation

IFR operations

- Due to the prevailing wind RWY 19 is mainly used.
- Inbound aircraft will follow its assigned STAR. At a certain distance from the CTV VOR (8d or 11d, see blue circles in the figure) aircraft will turn to a heading of 010°. From there the aircraft will be vectored to RWY19. Depending on the weather the aircraft will:
 - Land visually (VMC)
 - Perform an ILS approach (IMC).
- Outbound aircraft will follow its assigned SID.
- Surveillance based system available in the TMA. Minimum separation of 5 NM.
- Visual separation within the CTR.
- Peak hours capacity at FACT:
 - Generally, the primary peak is between 08:00-09:00z (Predominately Departures) – Average 22 per hour
 - The secondary peak 12:00-1300z (Predominately Arrivals) – Average 18 per hour

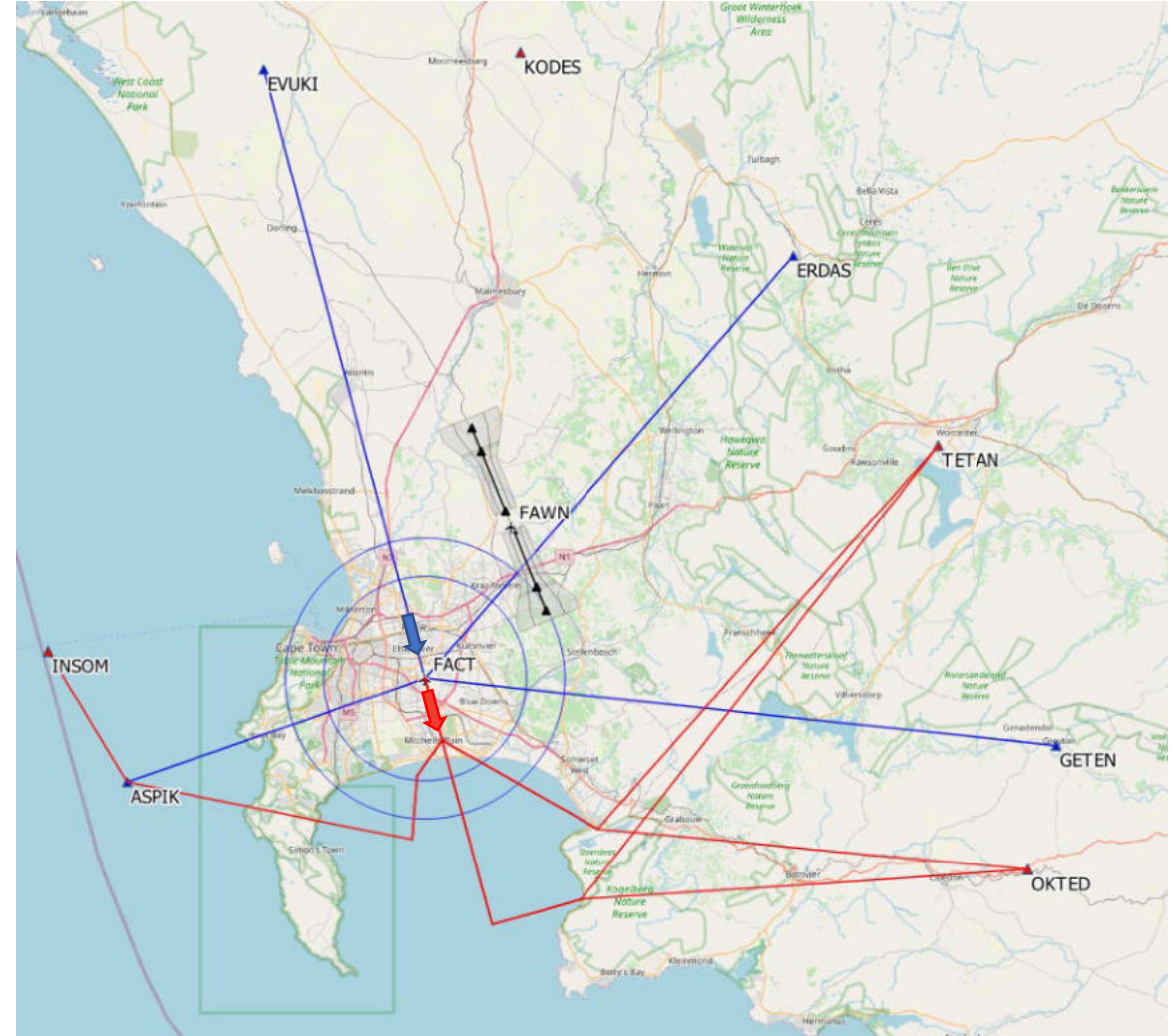

Schematic overview of the procedures for RWY 19. Arrivals in blue and departures in red

FAWN Operations

Current operation at Cape Winelands

VFR traffics avoids FACT airspace

From a procedural perspective the FAWN VFR traffic should not interfere with the FACT IFR traffic since the VFR operation is below the TMA A and outside the CTR of FACT. The main characteristics of the VFR procedures are indicated down below. Full description of the procedures can be found in the SA-AIP.

An Air Traffic Controller indicated local pilots operating from FAWN adhere to this. However, pilots who are not familiar at FAWN tend to fly at a higher altitude. Therefore, the crossing IFR traffic is instructed to fly at a higher altitude.

Circuit procedures:

- All inbound traffic shall approach the airfield at 2000FT ALT from 5NM.
- Join overhead at 2000FT ALT, to enter a left-hand pattern for either runway 05/23 or 14/32.
- Aircraft leaving the area must maintain 1500FT ALT until 5NM.
- Transiting aircraft to avoid overflying the airfield and to maintain 2000FT ALT from 5NM until past the airfield.

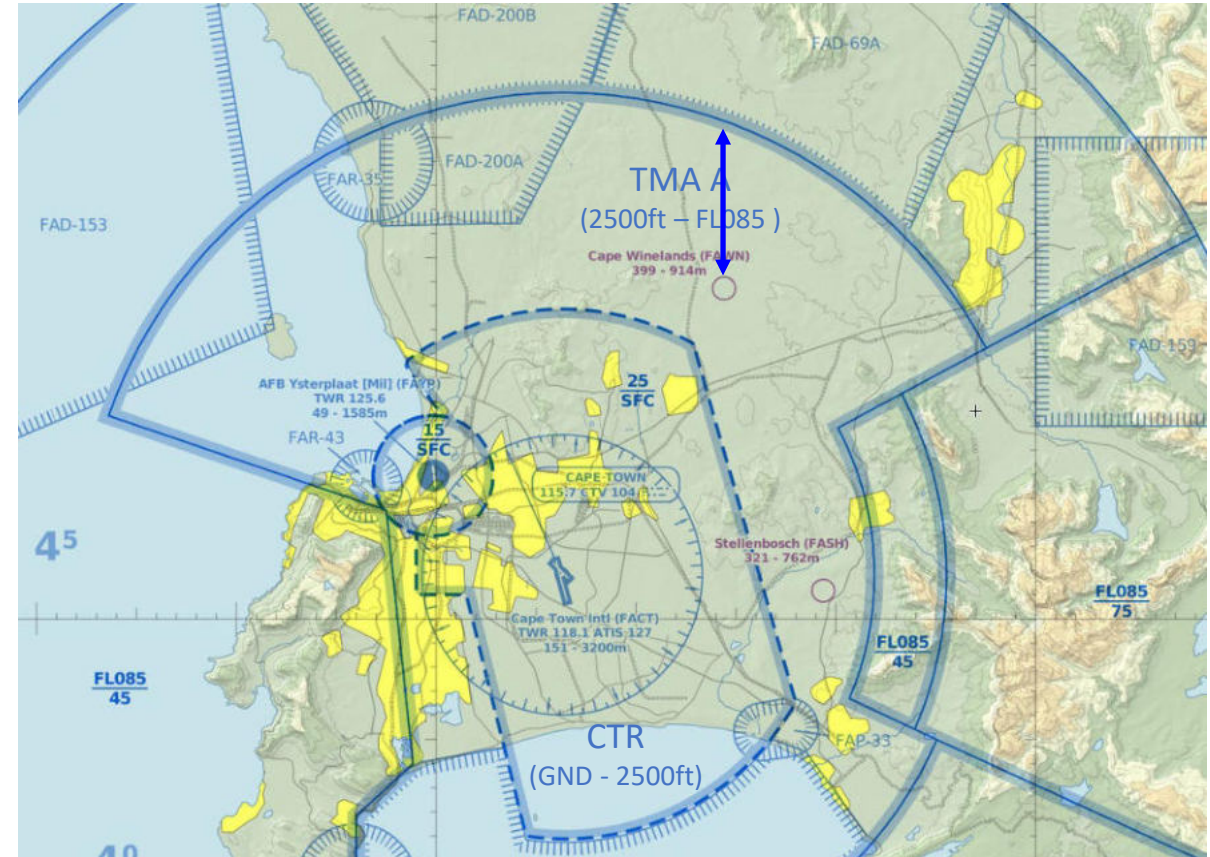

VFR aeronautical chart

FASH Operations

Current operation at Stellenbosch

VFR traffic avoids FACT airspace

- FASH is considered a VFR airport.
- VFR traffic from predominantly club members.
- VFR traffic operating at FASH is considered not to interfere with the FACT IFR traffic since it operate outside of controlled airspace in the FACT SRA.
- VFR traffic is considered mostly training flights between FASH and FAD-69A and/or FAD-69B (Stellenbosch Flying Training Area).
- The VFR procedures associated with operations at FASH can be obtained from the SA-AIP and is summarised below:
 - ✓ Right Hand Circuit apply to RWY 19
 - ✓ Left-Hand Circuit apply to RWY 01
 - ✓ Circuit to be flown West of the airport and within 2.5NM from FASH.
 - ✓ ACFT joining overhead the airfield shall join at 1 800 FT ALT or below.
 - ✓ Departing aircraft shall only commence the crosswind turn at 1000 FT ALT or above.

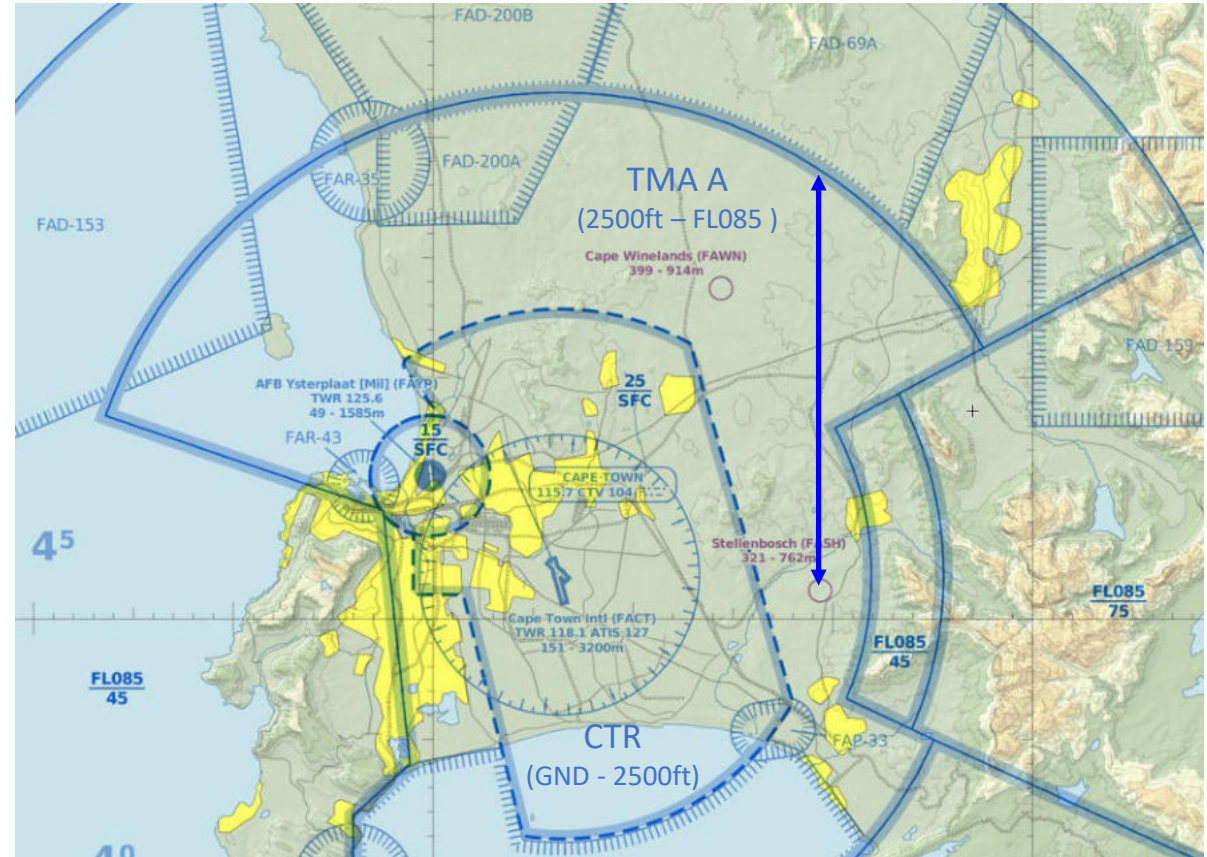

VFR aeronautical chart

FAYP Operations

Current operation at Ysterplaat Airforce Base

Traffic at the Airforce Base avoids controlled airspace

- Mostly Military/State traffic allowed to land and/or take-off at Ysterplaat
- No IFR procedures.
- No VFR procedures published.
- Mostly VFR traffic operating within/through the Ysterplaat ATZ
- On average 433 movements per month which include:
 - Landings & Take-offs
 - Overflights (or transitional flights) & Local flights (training, military operations, etc.)
- Traffic types and frequency traffic operating within the Ysterplaat ATZ:

High frequency	Medium frequency	Low frequency
EC120	AS35	BK117
RH44	UH1H	L39
TC06	B407	HAWK
PA 28	A119	C47T
C172	RV14	BE9T
C150	RV20	C208
PA28B	PC7	C130
PA38	GYRO COPTER	PC12
PA34	C210	A109
B206	LYNX/SL300	
AS32		
DV20		
RH22		
B407		
PA34		

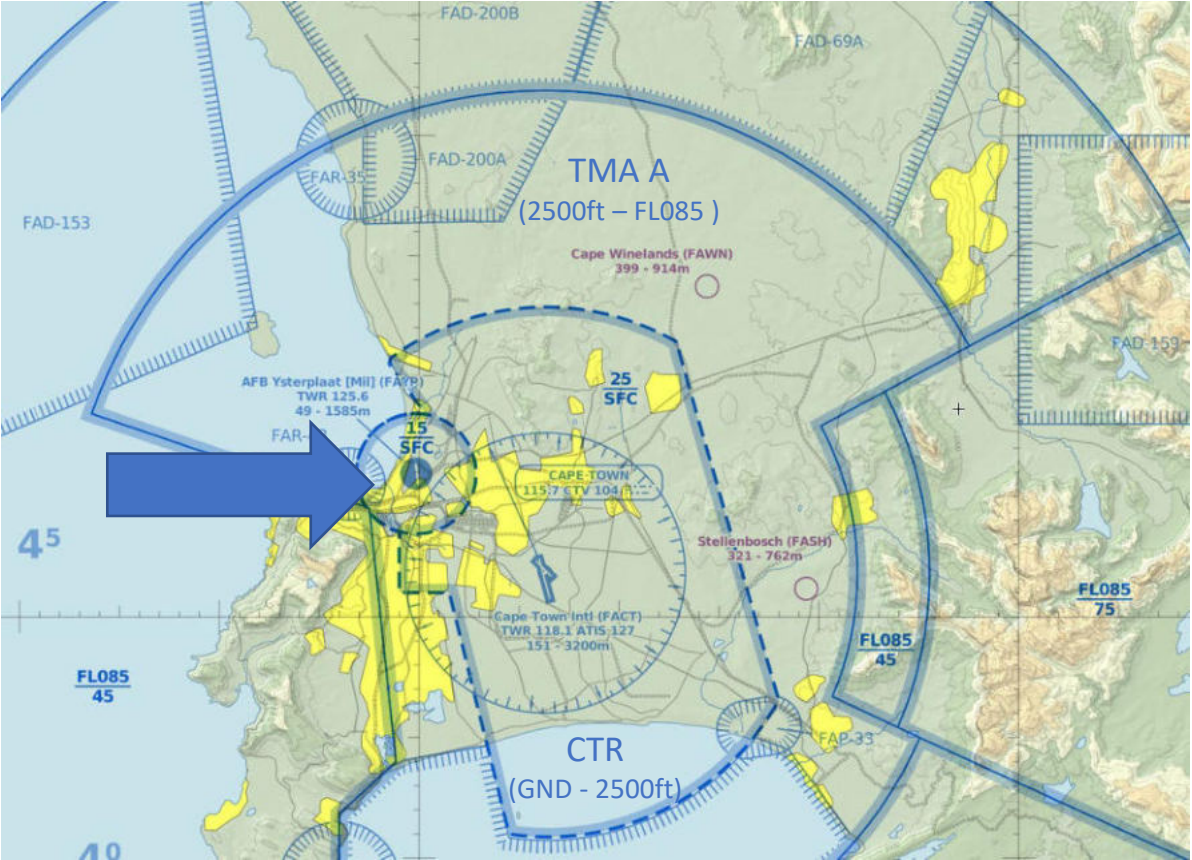

The Ysterplaat airspace (ATZ) as illustrated in an aeronautical chart

Morningstar Operations

Current operation at Morningstar Airfield

Morningstar Airfield is considered a VFR unlicensed airfield with substantial GA activity

- VFR traffic is predominantly from club members.
- VFR traffic operating at Morningstar is considered not to interfere with the FACT IFR traffic since it operates outside of controlled airspace in the FACT SRA.
- VFR traffic is considered mostly recreational and training flights between Morningstar, FASH and FAD-69A and/or FAD-69B (Stellenbosch Flying Training Area).
- The VFR procedures associated with operations at Morningstar can be obtained from its website and is summarised below:
 - Join overhead the field at 1500ft altitude
 - Descend on the Western dead side to join the circuit at 1000ft altitude
 - 02 Right hand circuit
 - 20 Left hand circuit

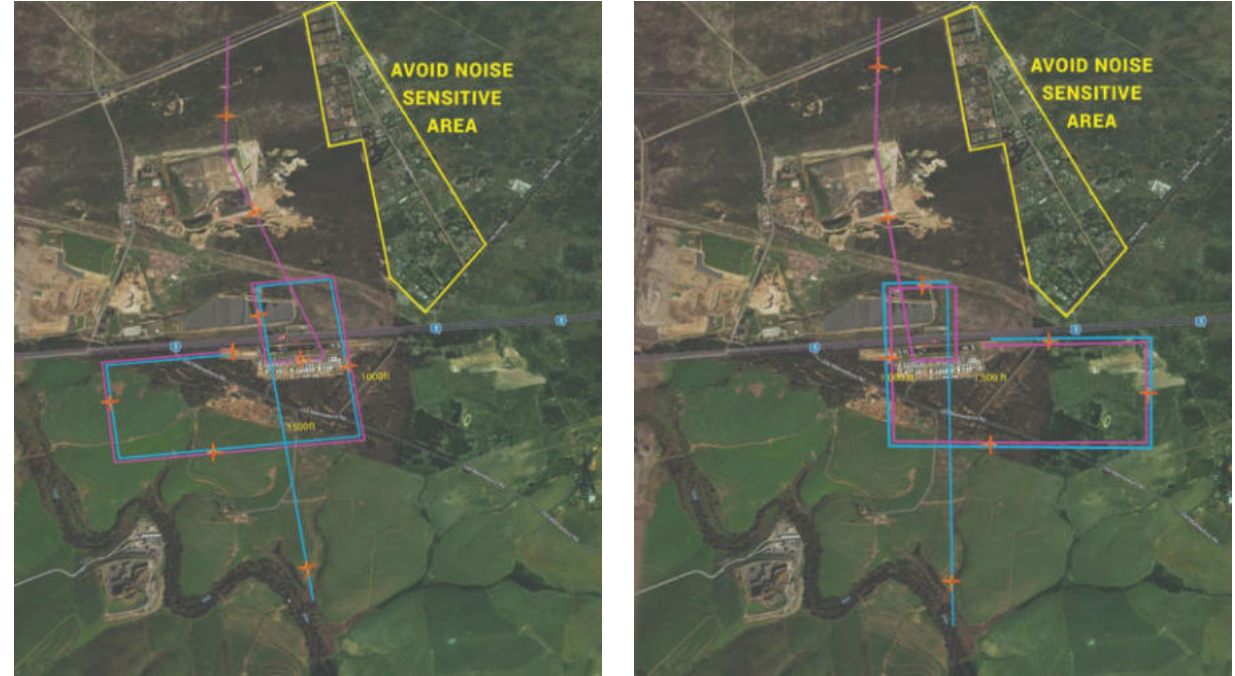

Charts indicating joining for Runway 02 (left) and 20 (right), from: <https://morningstarflyingclub.co.za/visiting-aircraft/>

Future Developments

Industry Developments

National and International Developments

Key developments within the global ATM System and within the South African environment (National Airspace Master Plan, NAMP) are taken into consideration

Airspace Organisation and Management (AOM)

- Integration of Unmanned Aircraft in all types of airspace.
- Enhancing information sharing to support Trajectory Based Operations (TBO)
- Airspace boundary reviews – rationalisation and harmonisation of airspaces.
- PBN implementation remain key – South African PBN roadmap.
- RNAV applications to enhance/support 4-D Trajectory Management.

Aerodrome Operations (AO)

- CDM at strategic, pre-tactical and tactical stages.
- Aerodrome throughput capacity matches the relevant airspace management capacity.
- Improve information exchange and coordination activities.
- Automation aids for dynamic planning.
- Precision approaches down to auto-land.

Demand and Capacity Balancing (DCB)

- A collaborative process between airspace user, airport operator and conflict management (ATS)
- Airspace concepts and design must take cognisance of airspace user equipage
- PBN will be implemented in accordance with the South African PBN Roadmap to ultimately achieve 4-D Trajectory Management
- A CDM process

Traffic Synchronisation (TS)

- Traffic synchronisation will be introduced to ensure the tactical establishment and maintenance of a safe, orderly and efficient flow of air traffic.

- Will encompass both the ground and airborne activities of ATM
- Eliminate choke points and, ultimately, to optimise traffic sequencing to achieve maximisation of runway throughput.

Airspace User Operations (AUO)

- The system will need to evolve to accommodate increasingly diverse types of vehicles and performance capabilities.

Conflict Management (CM)

- Strategic Conflict Management through airspace organisation and management
- Demand and Capacity Balancing, and Traffic Synchronisation
- Separation provision and collision avoidance.

ATM Service Delivery Management (ATM SDM)

- ATM Service Delivery Management principles will include:
 - Trajectory, profile, and aircraft or flight intent (predictability); and
 - Management by trajectory, clearance, and aircraft performance characteristic
- ATM SDM will ensure redundancy capacity is developed through a Disaster Recovery (DR)
- framework to protect the ATM Community and to enable to maintain or rapidly resume critical
- ATM SDM functions following a disaster.

Information Management (IM)

- System-wide interoperability and secure seamless information access and exchange requires introduction of significant changes in the business practices of managing information within the ATM system.

FAWN

FAWN

The development is expected to consist of a single runway of 3500m length as indicated below.

RWY NR	Dimensions [m]	Surface	Configuration
01/19	3500 x 45	Asphalt	Instrument code 4E

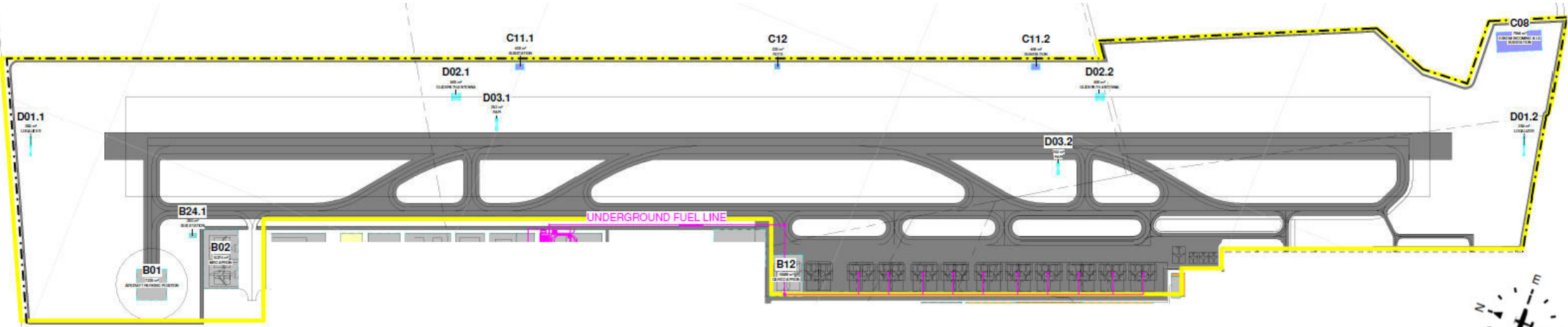

Proposed layout of main runway 01-19, from drawing 2024-3297 404, Rev 14, dated 2024-08-20

Proposed Development

Scheduled commercial traffic is expected to commence operations as soon as the new and upgraded facilities are ready. This includes both domestic and international traffic.

The proposed development will increase the available capacity for GA activities, in terms of hangarage, outside parking and take-offs and landings. It will also provide the infrastructure and facilities necessary to attract fixed-base operators and to operate scheduled commercial airline operations. The development aims to make it possible for more and larger aircraft to make use of the airport. In future the airport aims to attract turboprop and jet aircraft up to Code C with as many as 200 seats.

While the unscheduled flight operations (for flight schools, leisure & business and charter activities) are envisaged to increase, the airport also aims to introduce the FBO traffic, alongside scheduled domestic and international airline traffic.

The air traffic forecast provided by the Client (file: 2022-08-29 Traffic Forecast (Consultants).xls) indicates that scheduled domestic operations are expected to commence in 2026, with international flights anticipated in 2027. This means the infrastructure, procedures and airspace need to be in place to facilitate this.

No phased development is expected and the airport aims to be able to accommodate scheduled domestic and international traffic, including diversions from FACT, on IFR operations from the onset.

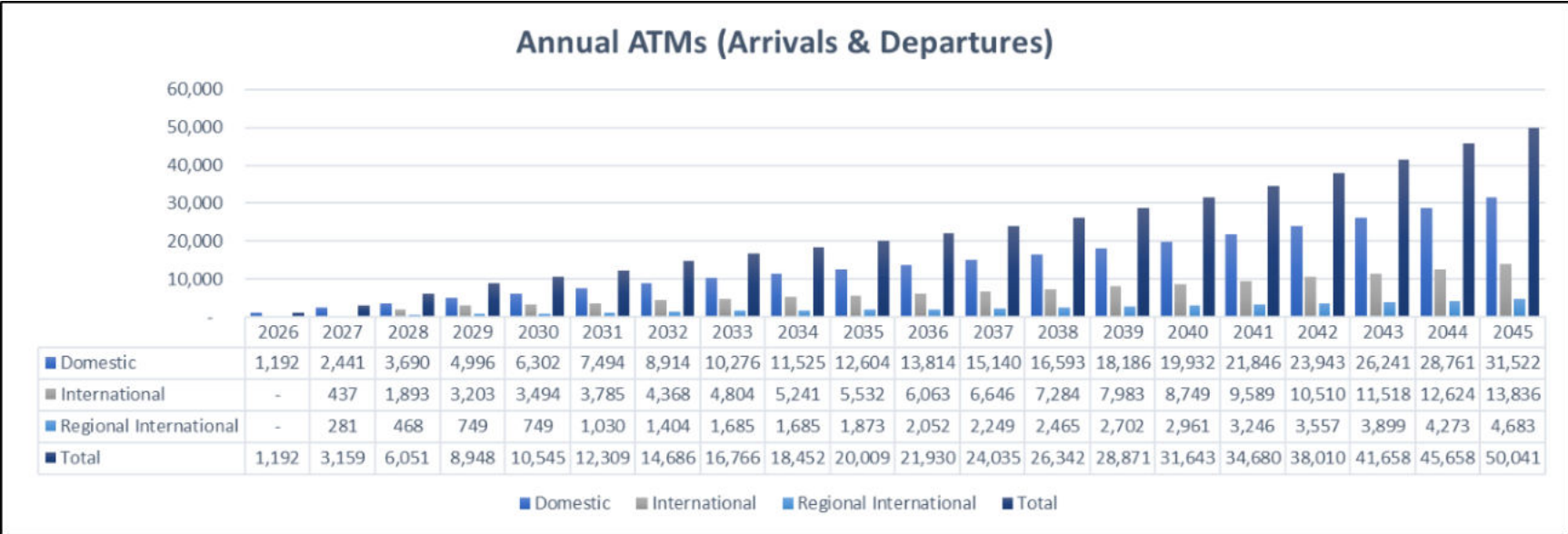

Forecast scheduled annual air traffic movements, from file: 2022-08-19 Traffic Forecast (Consultants)

FAWN

Cape Winelands Airport has forecast significant General Aviation activity, much of which will be VFR operations. Scheduled commercial IFR traffic is expected to take preference over VFR GA operations during peak hours.

Assumptions

- GA would decline over time as Scheduled Ops increase in activity due to prioritization of Scheduled Ops over GA
- Code A aircraft could make use of the cross-runway which would increase the capacity of the overall runway system
- 90% of GA are Code A aircraft

GA Peak Hour Demand 2030-2045

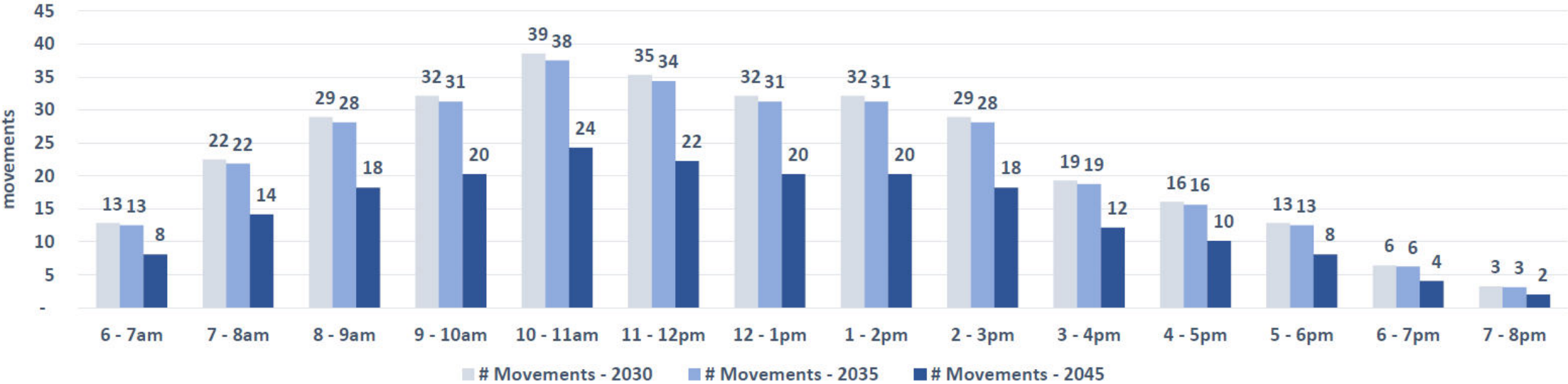

Forecast peak hour General Aviation movements, from file: 2022-07-08 CWA Traffic Prezo incl GA

FAWN

Forecast Per Hour

ATMS: Peak Hour	Arrival / Departures	2030	2035	2045
Domestic	Arrivals	3	4	10
	Departures	3	4	10
International	Arrivals	2	3	3
	Departures	2	3	3
Total	Arrivals	5	7	13
	Departures	5	7	13

Source: 2022-08-29 Traffic Forecast (Constultants).xlsx

General Aviation	Arrival / Departures	2030	2035	2045
Total	Arrivals	20	19	12
	Departures	20	19	12

Source: 2022-07-08 CWA Traffic Prezo incl GA.pdf

The current forecast of scheduled aircraft movements indicates an arrival and departure peak of 13 movements each per hour during the day. This forecast does not indicate the unscheduled (general aviation) peaks. Data on GA traffic from the previous provided forecast has been used. This has an arrival and departure peak of 12 movements each. This will lead to a combined peak of 50 movements per hour for the year 2045. It must be noted that the combined peak for 2035 is even slightly higher.

The abovementioned combined peak cannot be accommodated on a single runway in a mixed mode operation. However, it is very unlikely that the arrival and departure peak for scheduled and unscheduled traffic occur at the same time during the day.

In order to assess the runway capacity, the forecast should indicate the amount of arrivals and departures per hour during the day for scheduled and unscheduled aircraft.

Additional operational requirements can be made to spread the traffic. For example spread the arrival and departure peak and spread the scheduled and unscheduled movements.

It is indicated in the previous forecast that the scheduled traffic prevails over the unscheduled traffic. When only the scheduled flights are considered the runway should be able to accommodate the scheduled movements.

FACT

FACT Peak hour and capacity

Peak Hour FACT September 2022 and capacity overview

FACT IFR: Peak Hour SEP 2022	Arrival / Departures	March 2022
Arrival Peak	Arrivals	13
	Departures	10
Departure Peak	Arrivals	9
	Departures	17
Combined Peak	Arrivals, departures, local and overflight	35

Source: Daily movements Sept22

FACT IFR: Capacity	Arrival / Departures	Number of A/C per hour
Runway	Arrivals	15
	Departures	15
TMA	Arrivals & departures	35

Source: ATM Capacity April 2014.pdf

Based on the current information in hand the daily peak hour of the month September for the arrival peak is 13 and for the departures peak it is 17.

The current capacity of the runway throughput per hour at FACT is indicated as 15 arrivals and 15 departures. For the TMA airspace at FACT the maximum capacity is 35 A/C per hour (arrivals and departures combined).

The information merely provides some insights into the demand of aircraft in a certain period and the current established capacity for FACT. This information will be used to determine the possibility of a preliminary, high-level assessment to establish whether there is sufficient capacity to accommodate the current FACT peak traffic in combination with the forecast FAWN traffic. This does not take into account any forecast growth in peak hour traffic at FACT.

Cape Town International Airport – New Realigned Runway

A New Realigned Runway (NRR) is planned to be implemented at the airport

FACT is currently investigating a re-alignment of its main runway from 01-19 towards 36-18. Should the runway orientation change the current procedures will have to be adjusted accordingly. Early concept designs for the procedures for the NRR (shown on the following page) indicate that the procedures will be adjusted, and not be completely redesigned from start to end.

When the new re-aligned runway comes into operation, the 'old' runway 01-19 and the secondary runway 16-34 are expected to be decommissioned.

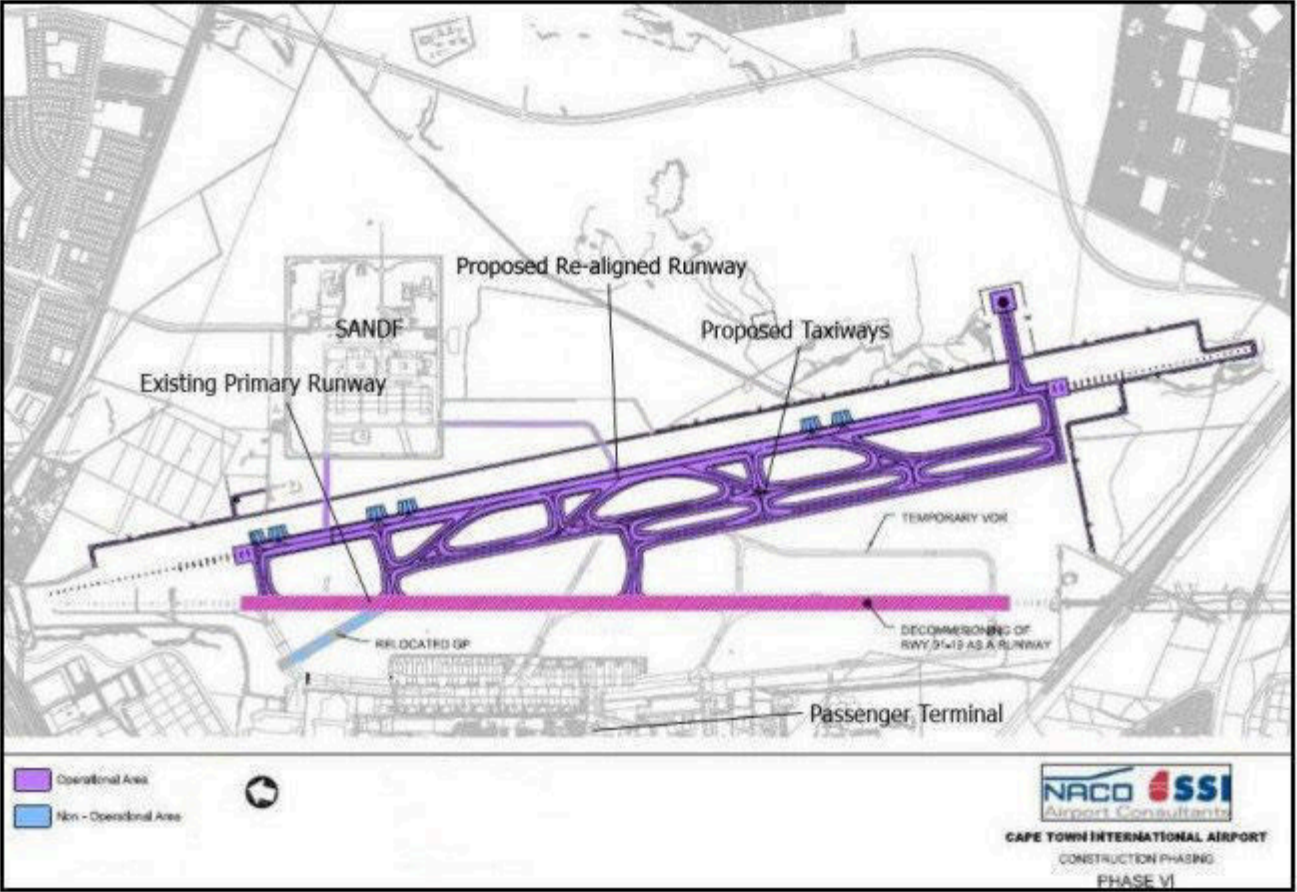
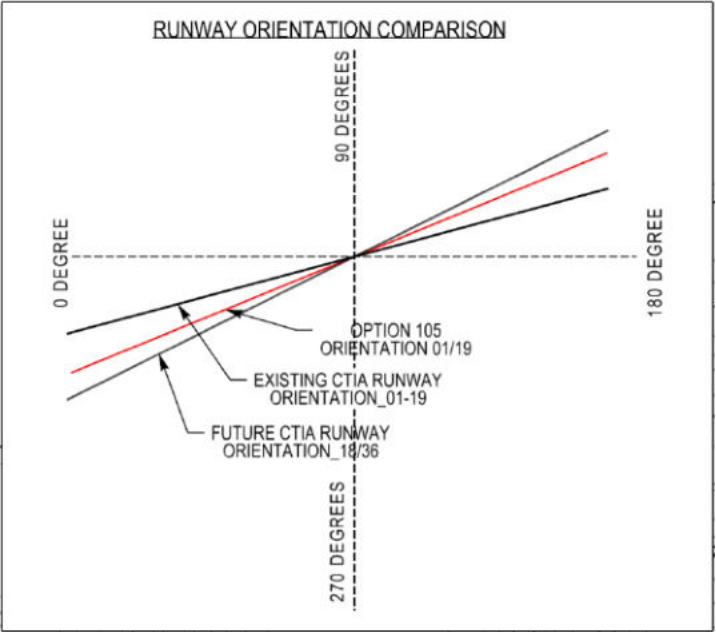

Proposed layout of the New Realigned Runway at Cape Town International Airport

Cape Town International Airport – New Realigned Runway

Proposed concept for RWY 36 arrivals and departures

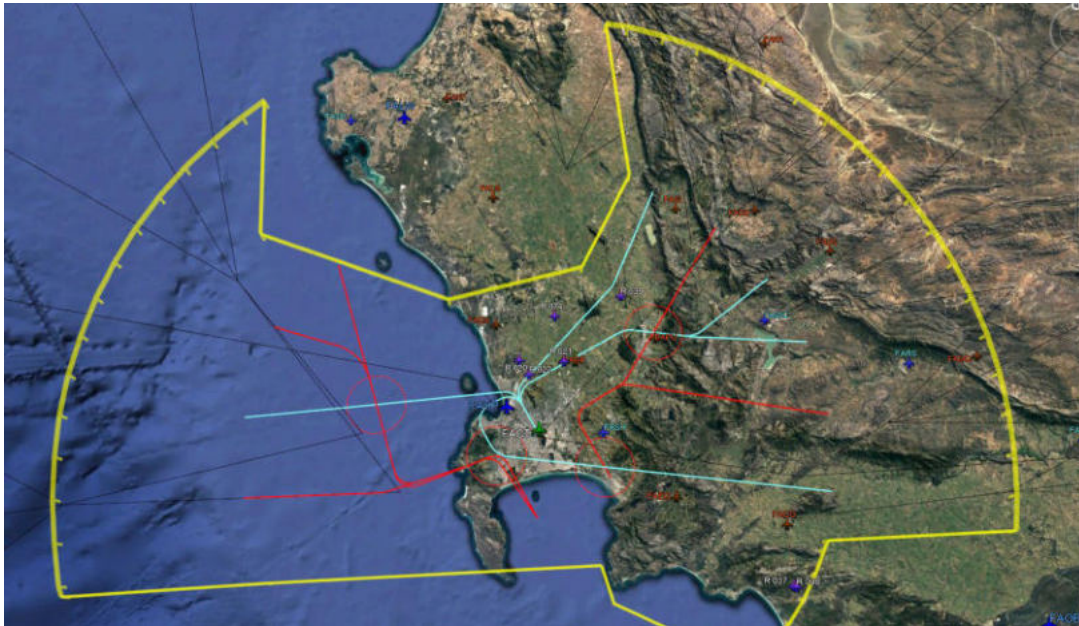

Google Earth figure illustrating conceptual routes for the New Realigned Runway 36

- In 2013 a TAAM study was done to assess Intergrated Noise Model (INM) output of the proposed new FACT runway 18/36 alignment using the published current approach and departure procedures.
- Conceptual designs for SIDs and STARs are utilising the same feeder fixes into and out of the Cape Town TMA.
- Continuous Climb (CCO) and Descent (CDO) operations are expected.
- CDO and CCO procedures must be separated by design.
- RNP/ILS Approaches for both runway 18 & 36.
- The same feeder fixes (entry and exit) are planned to be used.

Concept of Operations

Airspace Concept of Operations

The Airspace CONOPS aims to propose a comprehensive approach to flight operations at the airport, within the context of the existing situation and future developments

Status Quo

- Uncontrolled airspace at FAWN
- CTR and TMA at FACT
- NEMPA, Prohibited, Restricted and Danger areas
- Terrain and obstacles
- CNS/ATM in the region
- Nearby aerodromes:
 - FACT
 - FAYP
 - FASH

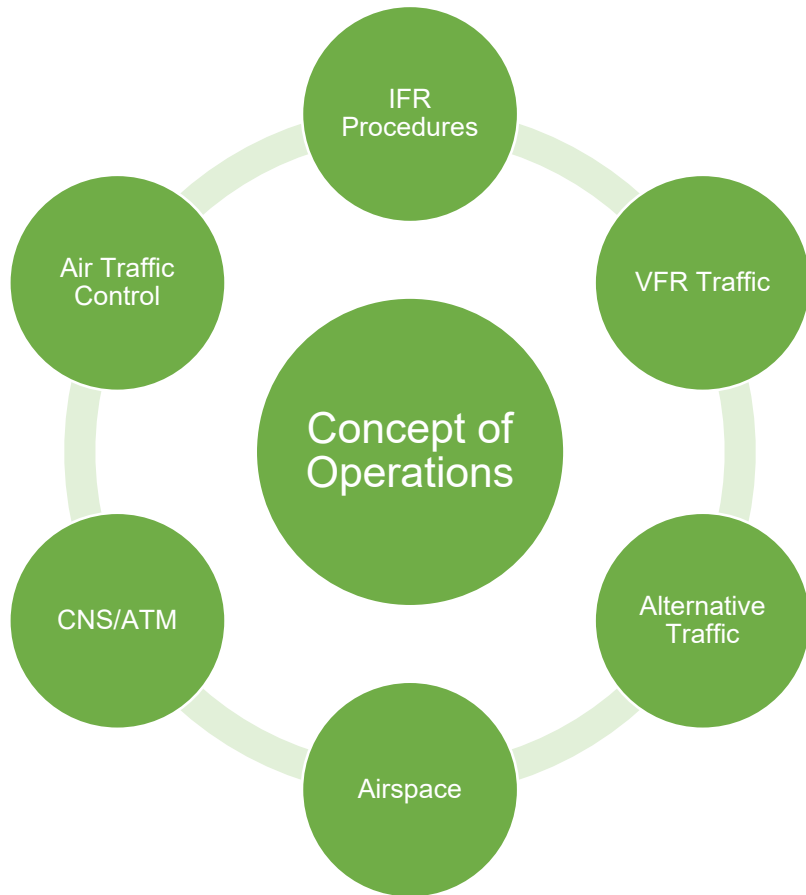

Future Developments

- National Airspace Master Plan
- PBN Roadmap
- Airspace boundary reviews
- Development of FAWN
- New Realigned Runway at FACT

Strategic Objectives and Operational Requirements

The Airspace CONOPS aims to enable the successful transition of CWA from its current state to a thriving commercial airport, operating safely within the regional airspace

Strategic Objectives

The Airspace CONOPS intends to achieve the following strategic objectives:

1. Enable the introduction of scheduled commercial traffic at CWA: As it develops, the airport intends to attract both domestic and international operators. The forecast air traffic movements and aircraft types are presented in this report.
2. Facilitate the growth of VFR traffic at CWA and in the region: The airport aims to facilitate the growth of General Aviation in the Western Cape region and provide a base for a range of private and commercial operations. This includes flight training operations.
3. Facilitate the introduction and expansion of alternative traffic flows: It is expected that the airport will see alternative traffic such as helicopter and Urban/Advanced Air Mobility (UAM/AAM) with remotely piloted aircraft systems (RPAS).
4. Seamless integration of CWA traffic with current operations in the area: Ensuring safety and minimizing disruptions to current users of the local airspace will be paramount to successful integration of the development.

Operational Requirements

The strategic objective can be translated into the following operational requirements for the Airspace CONOPS.

1. Enable independent operations of FAWN and FACT: Airspace for the two airports should be able to operated independently as much as possible, so as not to reduce capacity or restrict future growth. The introduction of CWA as a commercial airport with IFR operations should expand the overall capacity of the airspace in the region.
2. Minimize changes to the existing situation in the region: In order to minimize disruption, the need for training and the time required for implementation, the proposed CONOPS should keep the existing situation the same as much as possible. A major overhaul of airspace and redesign of all procedures in the region may be considered at a later stage within a wider context.
3. Minimize ATCO workload: Taking into account challenges experienced by ATC operators at FACT, and the importance of sufficient numbers of adequately trained personnel, the CONOPS should aim to simplify ATC operations. Additional ATCO may be required to handle the increase in traffic brought on by the development of CWA.

Instrument Flight Procedures

Introducing IFR procedures at FAWN

Considerations for the type of procedures

- Currently no (ground-based) navigational aids at FAWN.
- South Africa (and the rest of the world) is moving from conventional ground-based routes and procedures towards Performance-Based Navigation (PBN).
- PBN routes and procedures therefore seem an obvious choice for FAWN. Aircraft equipage/capabilities may be an issue. A fleet assessment needs to be performed to ensure the intended operators will be able to fly the proposed procedures.
- It is suggested to start with basic PBN:
 - RNP approaches (requires RNP APCH navigation specification);
 - RNAV SIDs and STARs (requires RNAV-1 navigation specification).
- All PBN routes and procedures will be supported by GNSS (GPS).
- Currently no SBAS coverage in South Africa. RNP approach procedures down to LNAV (no vertical guidance) and LNAV/VNAV (barometric vertical guidance) minima only. No LPV minima.
- To serve as an alternate for FACT, ILS approach procedures will be needed as well:
 - Will provide lower minima (terrain/obstacle environment permitting) thereby increasing the usability in low visibility conditions;
 - Will accommodate a larger fleet of aircraft.
- If a significant fleet share is not equipped for basic PBN (RNAV-1), conventional VOR procedures may need to be considered as well:
 - Will require an additional ground-based navigational aid (VOR);
 - May pose design challenges to prevent excessive minima/climb gradients.

Proposed instrument flight procedures (RWY 01 & RWY 19):

- RNP approach procedures
- ILS approach procedures
- RNAV SIDs (standard instrument departure procedures)
- RNAV STARs (standard terminal arrival routes)

Designing IFR procedures at FAWN

Key factors driving the design

- 1. Proximity to FACT:** It is assumed that RWY 01/19 is approximately aligned with the current and new realigned FACT runway. Turns towards FACT should be avoided as this will add to the complexity of integrating FAWN and FACT traffic.
- 2. Danger area 69A (Stellenbosch Flying Training Area):** Should be avoided as far as practicable. Approaches to RWY 19 will not be able to avoid this airspace.
- 3. High terrain (up to 4,100ft AMSL) 10NM SE of FAWN:** Complicating early left turns to the east in departures and missed approaches to the south, and short turns onto the final approach course to RWY 01.
- 4. High terrain (up to 3,800ft AMSL) 13-16NM S of FAWN (below extended centerline):** Controlling minimum climb gradients for departures and missed approaches to the south, and potentially requiring step downs and/or increased descent gradients in approaches to RWY 01.
- 5. Various obstacles (up to 193m AMSL) in the vicinity of FAWN (along the extended centerlines):** Requiring step down fixes in non-precision approaches (LNAV) to prevent excessive minima.

Keeping IFR traffic outside/below FACT airspace will not be possible.

Note: Shown are standard final approach segments to RWY 01 and RWY 19:

- FAF altitude: 2,000ft AMSL
- Glide path angle: 3°
- Length: ~5NM

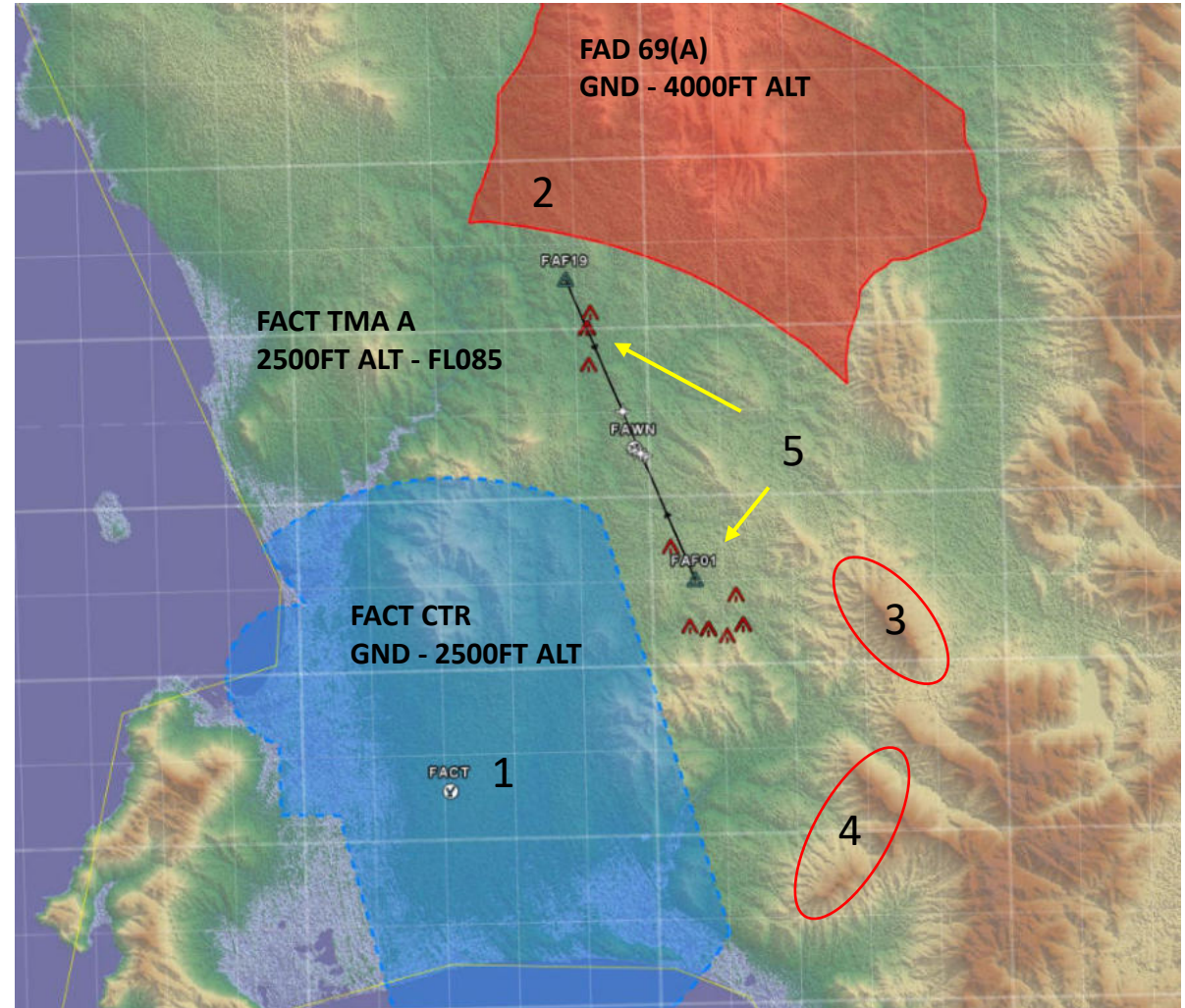

Standard final approach segments to runways 01 and 19

Conceptual designs

The designs are developed to obtain a first impression of feasibility and usability

- Based on ICAO PANS-OPS design criteria (ICAO Doc 8168 Procedures for Air Navigation Services - Aircraft Operations, Volume II – Construction of Visual and Instrument Flight Procedures, Seventh Edition, 2020, Amendments 1 to 9)
- Terrain data used:
 - ASTER (Advanced Spaceborne Thermal Emission and Reflection Radiometer) GDEM (Global Digital Elevation Model) version 3, from: <https://www.earthdata.nasa.gov/news/new-aster-gdem>
- Obstacle data used:
 - SACAA South African Obstacle File (SOF_20220811) from: <http://www.caa.co.za/Pages/Obstacles/SA%20Obstacle%20File.aspx>
 - ATNS OLS survey 2022

Departure procedure from RWY 01

Conceptual design of an RNAV SID

- RNAV SID from RWY 01 with transitions to TETAN and OKTED.
- GNSS & RNAV-1 navigation specification required.
- Merging with current FACT SID RWY 01 at WN102 (R090 RIV 22 DME). Note that TETAN and OKTED SIDs from FACT have been suspended due to the withdrawal of RIV.
- Speed limit of 210kts IAS in turn.
- Requires a minimum climb gradient (PDG) of 3.5% (OKTED) or 3.9% (TETAN) to clear the high terrain northeast of WN102.
- Crossing the border of FAD 69(A) above 4,000ft would require a minimum climb gradient of 10%.

Avoiding FAD 69(A) does not seem feasible.

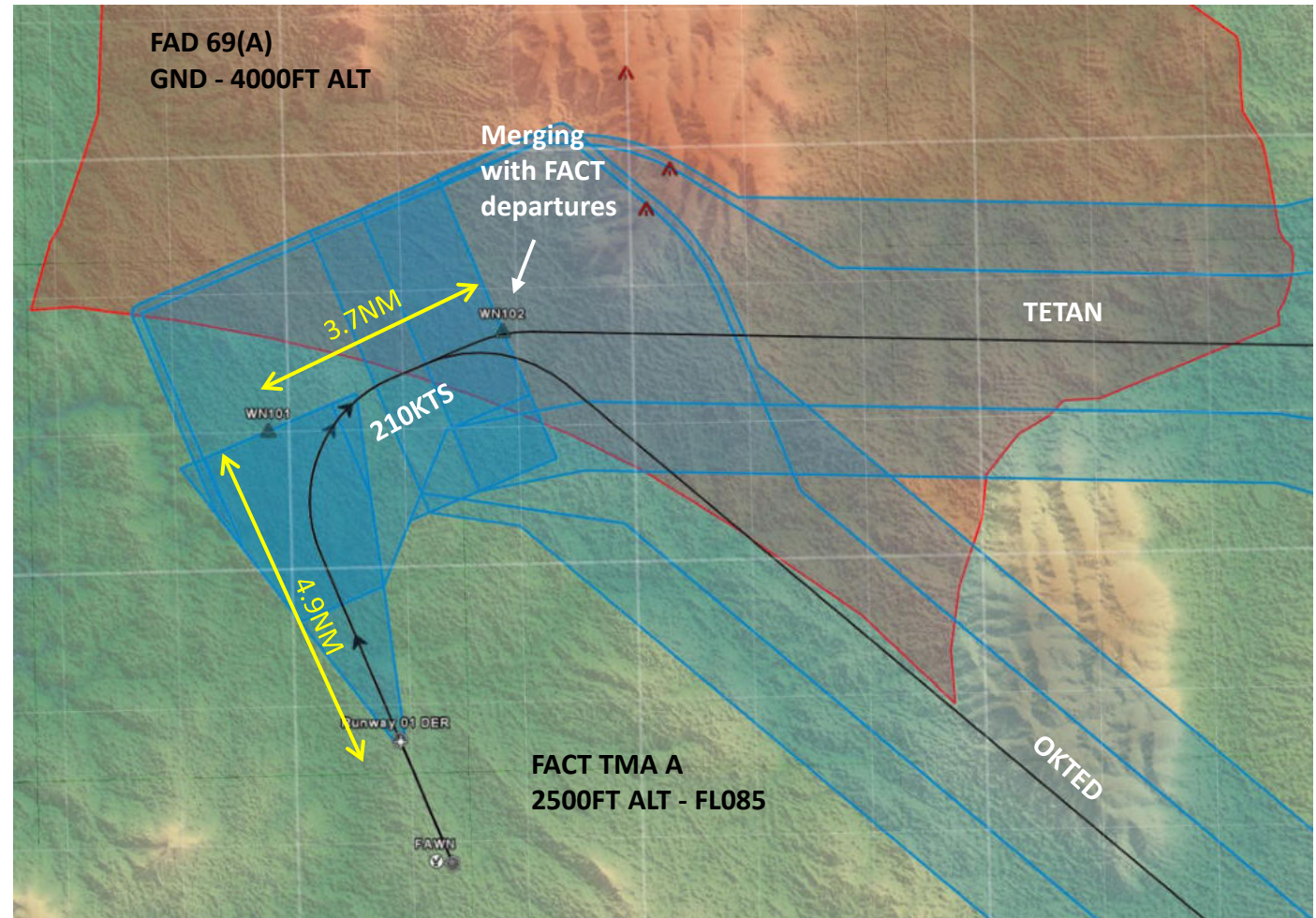

RNAV Standard Instrument Departure (SID) from runway 01

Departure procedure from RWY 19

Conceptual design of an RNAV SID

- RNAV SID from RWY 19 with transitions to TETAN and OKTED.
- GNSS & RNAV-1 navigation specification required.
- Merging with current FACT SIDs RWY 19 (OKTED 1B and TETAN 1B) at WN201.
- Requires a minimum climb gradient (PDG) of 3.9% to clear high terrain below extended centerline (at a distance of 16.9NM from the departure end of the runway).

An earlier left turn to the east does not seem feasible.

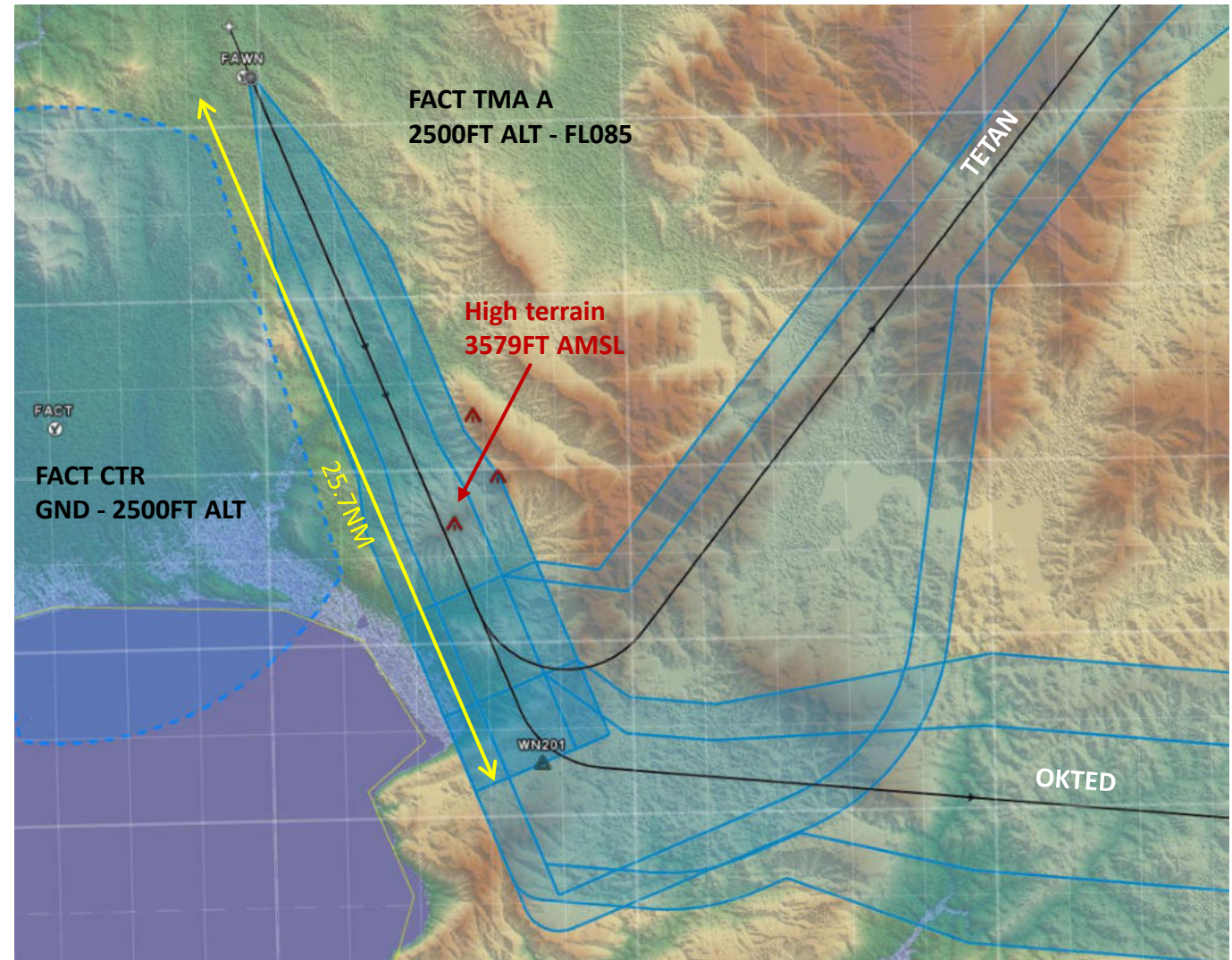

RNAV Standard Instrument Departure (SID) from runway 19

Approach procedure to RWY 01

Conceptual design of an RNP approach

- RNP approach to RWY 01 down to LNAV (no vertical guidance) and LNAV/VNAV (barometric vertical guidance) minima.
- GNSS & RNP APCH navigation specification required.
- Lowest DH is 250ft (Type A approach).
- Straight approach from the south to avoid high terrain.
- FAF altitude is 3,000ft AMSL, SDFs in initial and final approach (LNAV).
- Increased descent gradient in the initial approach (between IAF and IF) of 5.2% due to high terrain.
- Standard missed approach climb gradient (MACG) of 2.5%.
- *Indicative minima* (based on limited assessment of obstacles/terrain):

OCA (OCH) in FT	A	B	C	D
LNAV	800 (401)			
LNAV/VNAV	541 (137)	554 (150)	562 (158)	572 (168)

The missed approach procedure will likely interfere with one or more FADs. A turn as soon as practicable avoiding the FADs does not seem feasible.

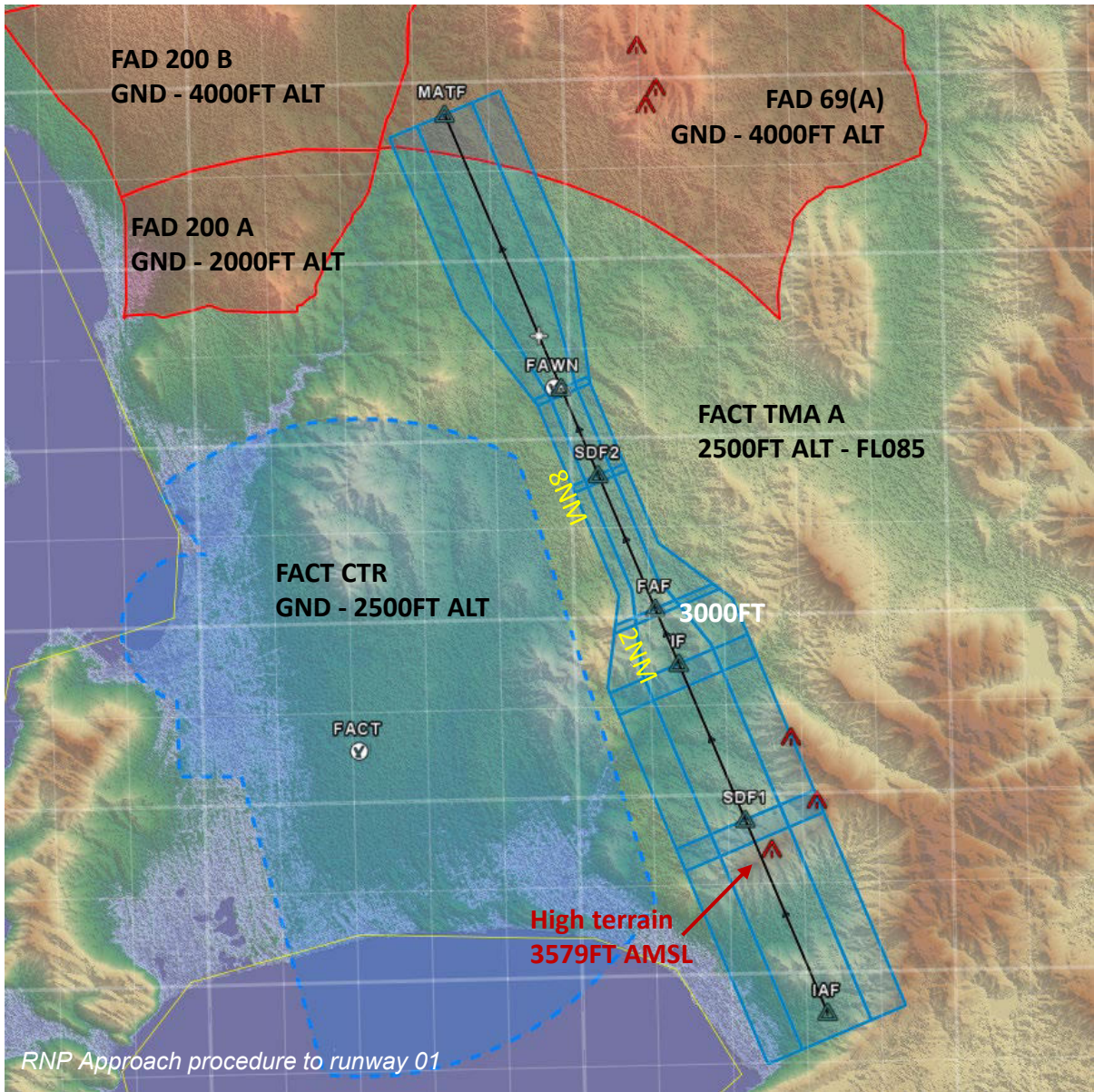

Approach procedure to RWY 19

Conceptual design of an RNP approach

- RNP approach to RWY 19 down to LNAV (no vertical guidance) and LNAV/VNAV (barometric vertical guidance) minima.
- GNSS & RNP APCH navigation specification required.
- Lowest DH is 250ft (Type A approach).
- Standard T-bar arrangement (only IAF northeast of IF is shown).
- FAF altitude is 2,000ft AMSL, SDF at 1.6NM from THR (LNAV).
- Minimum altitude at IAF is 3,400ft AMSL (to clear high terrain east of IAF) leading to an increased descent gradient in the initial approach (between IAF and IF) of 5.2%.
- Speed limit of 185kts IAS in turn.
- High terrain in the missed approach determines the OCA/H. The lowest minima require a missed approach climb gradient (MACG) of 3.0%.
- Indicative minima (based on limited assessment of obstacles/terrain):

OCA (OCH) in FT		A	B	C	D
LNAV	MACG 2.5%	1010 (662)	1040 (692)	1060 (712)	1080 (732)
	MACG 3.0%	800 (452)			
LNAV/VNAV	MACG 2.5%	792 (444)	805 (457)	824 (476)	851 (503)
	MACG 3.0%	478 (130)	490 (142)	498 (150)	509 (161)

Any instrument approach procedure to RWY 19 will interfere with one or more FADs.

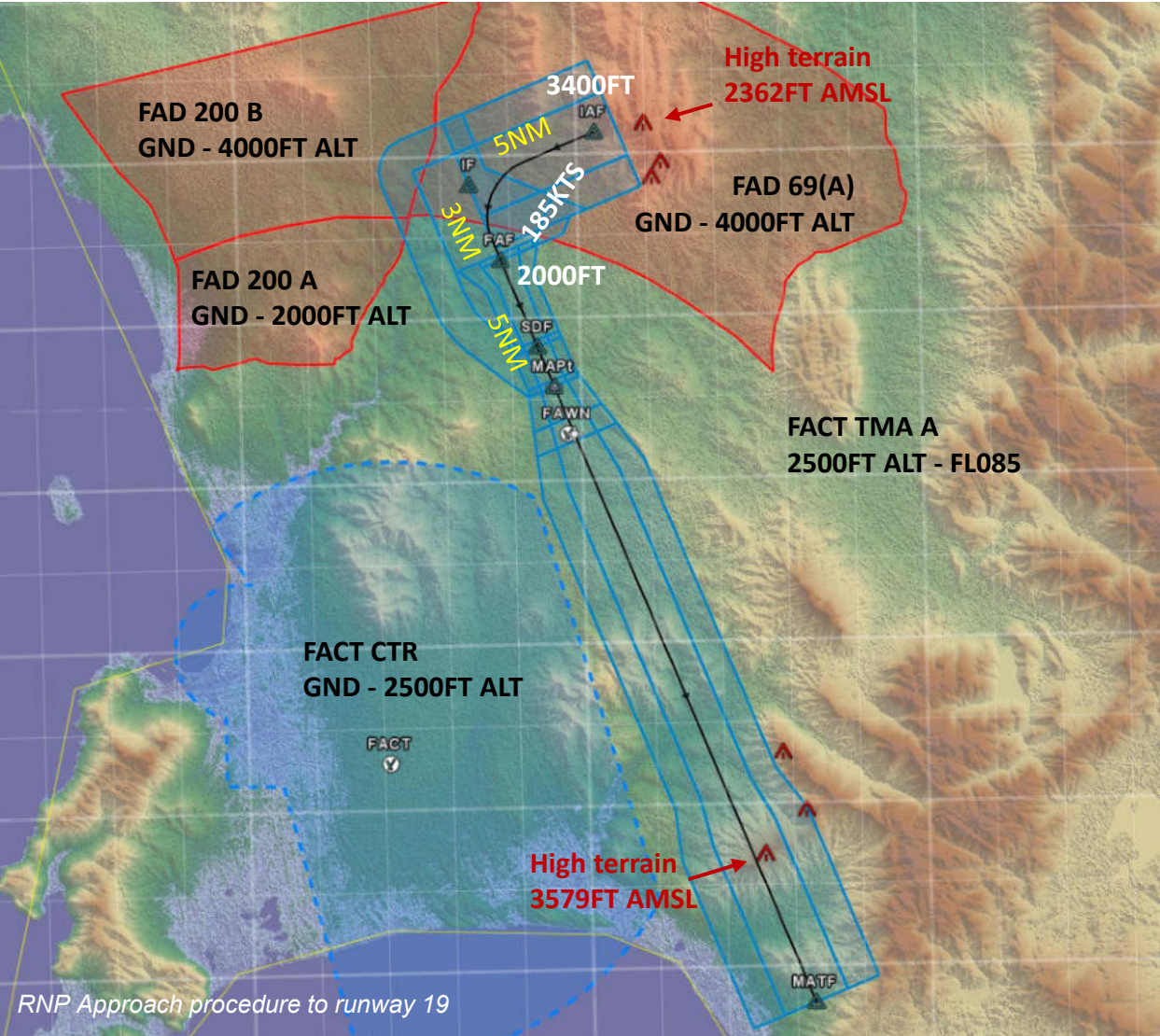

RNP Approach procedure to runway 19

ILS procedures

Increasing the usability in low visibility conditions

General design characteristics

- Similar RNAV initial and missed approach segments
- Track guidance and vertical guidance in intermediate and final approach supported by ILS
- RNAV-1 navigation specification required

ILS CAT I

- Lowest DH is 200ft
- *Indicative* minima (based on limited assessment of obstacles/terrain):

ILS RWY 01

OCA (OCH) in FT	A	B	C	D
CAT I	534 (130)	546 (142)	554 (150)	565 (161)

ILS RWY 19

OCA (OCH) in FT		A	B	C	D
CAT I	MACG 2.5%	792 (444)	805 (457)	813 (465)	823 (475)
	MACG 3.0%	478 (130)	490 (142)	498 (150)	509 (161)

ILS CAT II

- Lowest DH is 100ft
- *Indicative* minima (based on limited assessment of obstacles/terrain):

ILS RWY 01

(OCH) in FT	A	B	C	D
CAT II	(42)	(59)	(71)	(85)

ILS RWY 19

(OCH) in FT		A	B	C	D
CAT II	MACG 2.5%	(356)	(374)	(385)	(400)
	MACG 3.0%	(42)	(59)	(71)	(85)

Adding an ILS will provide benefit, especially to operators without RNP APCH + Baro-VNAV capabilities.

VFR Traffic

VFR Traffic

VFR traffic plays a vital role in the Cape Town area



Indicative VFR traffic flows avoiding FAWN

- With the proposed main runway at FAWN in a North-South orientation it is advisable that VFR traffic join from the East or West (Also see the Cape Town International VFR routes).
- All VFR traffic routing in the Cape Town SRA must remain clear of the proposed controlled airspace for FAWN.
- Clearance into and out of the Cape Winelands Airport will be obtained from the ATC.
- The major flows will be to and from the General Flying Areas and other training areas towards the East of FAWN.
- VFR traffic must comply with the SA-AIP procedures operating within the FACT SRA.
- Once the FAWN airspace has been finalised and implemented standard VFR routes may be developed for FAWN.
- FAWN airspace will affect the standard VFR routes for Cape Town International and if/when they are reviewed FAWN airspace should be considered.
- A key VFR route is between Morningstar and FASH. Important to note is that this route passes between FACT CTR and the FAWN airport.

Morningstar and FASH's Roles as a GA Activity Hubs

Both club's extensive GA activities, including the number of active members, aircraft hangars, and training schools, necessitate a thorough reassessment of GA activity in the vicinity of CWA. The CWA airspace design will incorporate a detailed assessment of these operations to accurately reflect their impact on safety and efficiency.

GA Activity Data Integration

To ensure the safety and operational effectiveness of the airspace, comprehensive data on GA operations, particularly those originating from Morningstar and FASH, will be gathered and included in the final design. This will involve a detailed traffic assessment, covering the nature of flights, aircraft types, flight durations, and traffic density.

Consideration of VFR Traffic

Recognizing the importance of Visual Flight Rules (VFR) traffic, especially training flights by less experienced pilots, the airspace design will include specific routing considerations for VFR traffic. This will ensure that VFR routes are planned alongside Instrument Flight Rules (IFR) routes to prevent congestion and maintain safety.

Merging Traffic Flows

Merging IFR traffic – Northern operation

Draft conceptual merger of IFR traffic to/from FAWN with existing routes to/from FACT

How potentially the FAWN IFR traffic can merge with FACT IFR traffic is indicated in the figure for a northern operation. On the arrival procedures towards FACT (in blue) at certain diversion points routes can be initiated towards FAWN (in green).

For the departures from FAWN (in purple) these can be merged into the SIDs originating from FACT (in red). Please note that for the northern operation the FACT SIDs TETAN and OKTED are not currently stated in the AIP. For FAWN these SIDs could be considered depending on the need for these routes towards this direction.

In this manner the FACT operation and ATM system around it can function in principal as is, with no or minor adjustments towards the general concept of FACT. For ATC a gradually increment of the FAWN traffic will lead to a smoother introduction of the FAWN operation next to the current FACT operation.

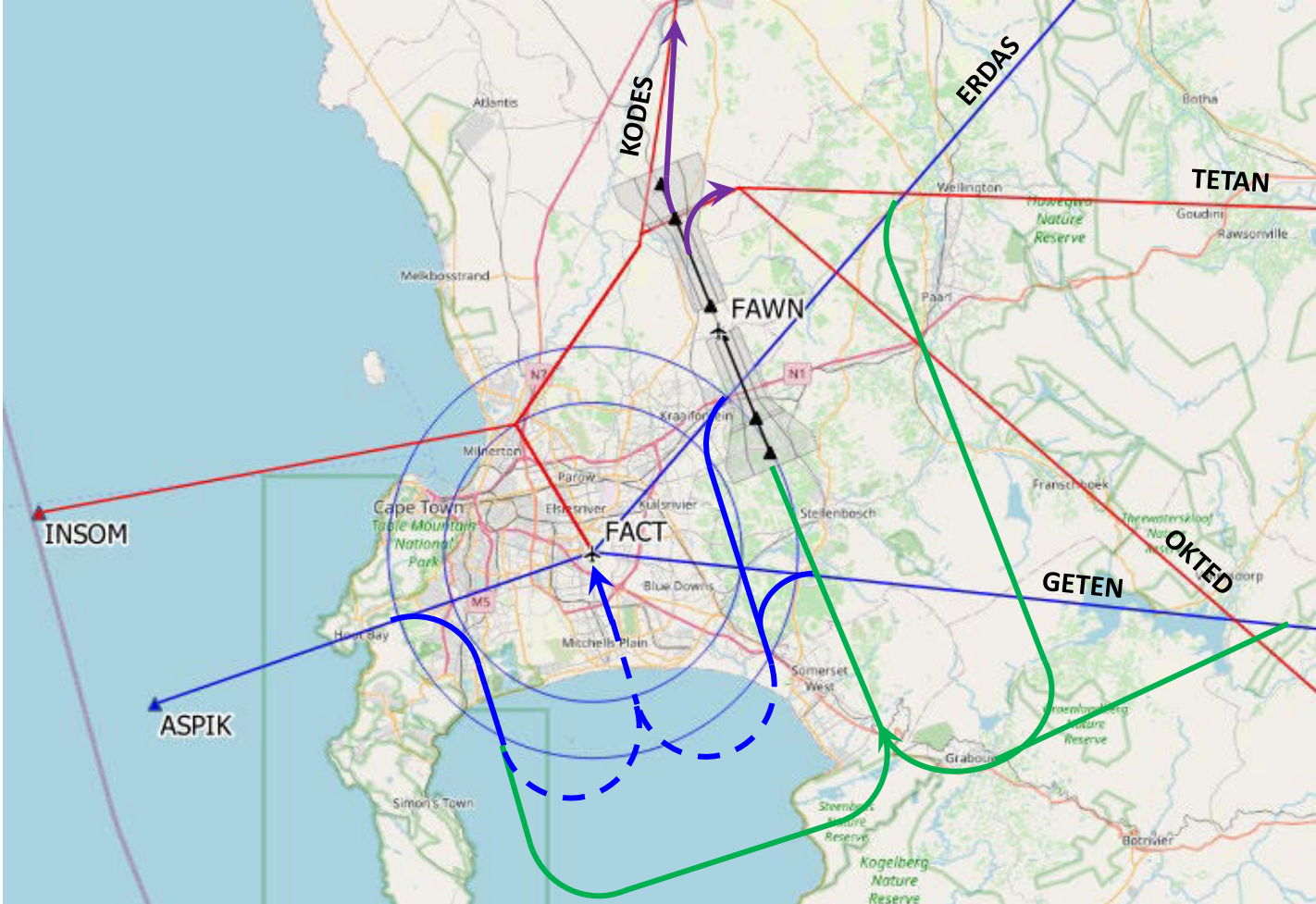

Schematic overview of potential merger of traffic flows in a northern operation

Merging IFR traffic – Southern operation

Draft conceptual merger of IFR traffic to/from FAWN with existing routes to/from FACT

The same principal has been applied how to potentially merge the FAWN IFR traffic with the FACT IFR traffic. This is indicated in the figure for a southern operation. On the arrival procedures towards FACT (in blue) at certain diversion points routes can be initiated towards FAWN (in green). For the departures from FAWN (in purple) these can be merged into the SIDs originating from FACT (in red).

The diversions and merge points are not necessarily located at the lateral deviation from the FACT routes. A vertical separation can already be introduced at the TMA borders. In this manner CDO's and CCO's can be accommodated for a more efficient flight.

For the future realignment of the FACT runway, that is foreseen from 01/19 towards 18/36, and the provided accompanying concept routes for this RWY realignment can still be accommodated draft concept.

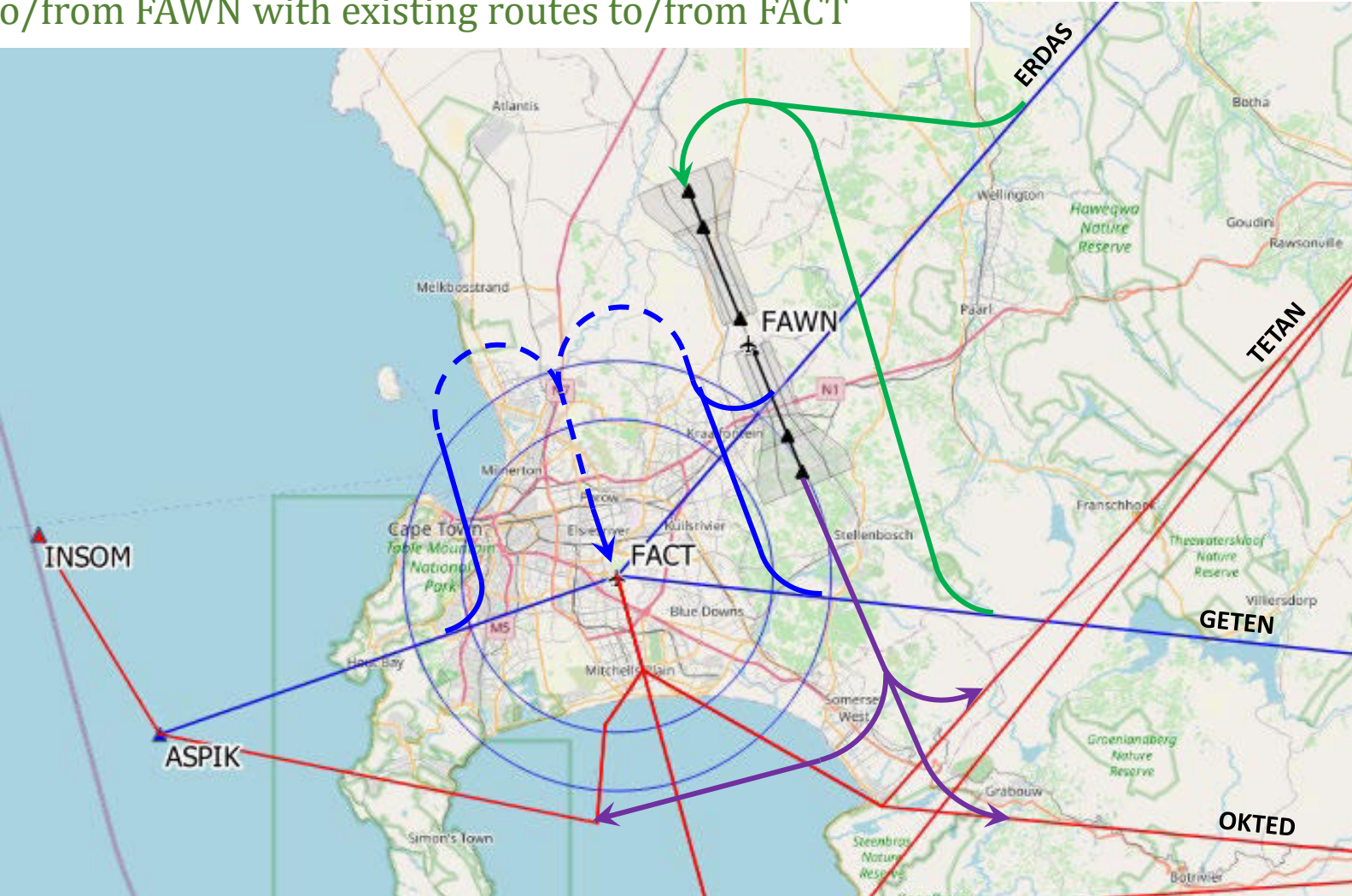

Schematic overview of potential merger of traffic flows in a southern operation

Capacity IFR traffic – Southern operation

Draft conceptual capacity of IFR traffic to/from FAWN with existing routes to/from FACT

FAWN IFR: Peak Hour	Arrival / Departures	2030	2035	2045
Total	Arrivals	5	7	13
	Departures	5	7	13

FACT IFR: Peak Hour SEP 2022	Arrival / Departures	March 2022
Arrival Peak	Arrivals	13
	Departures	10
Departure Peak	Arrivals	9
	Departures	17
Combined Peak	Arrivals, departures, local and overflight	35

The current capacity of the TMA of FACT is reported to be 35 flights per hour.

This implies further investigation is required to establish the potential need for improvement of airspace capacity. It must be noted that when peaks from FACT and FAWN occur at the same moment during the day an improved capacity will be necessary to accommodate the forecasted traffic. In an effort to manage ATCO workload and increase airspace capacity some considerations need to be taken into account such as; sectorization of TMA's, extended arrival management systems and reduction of separation criteria .

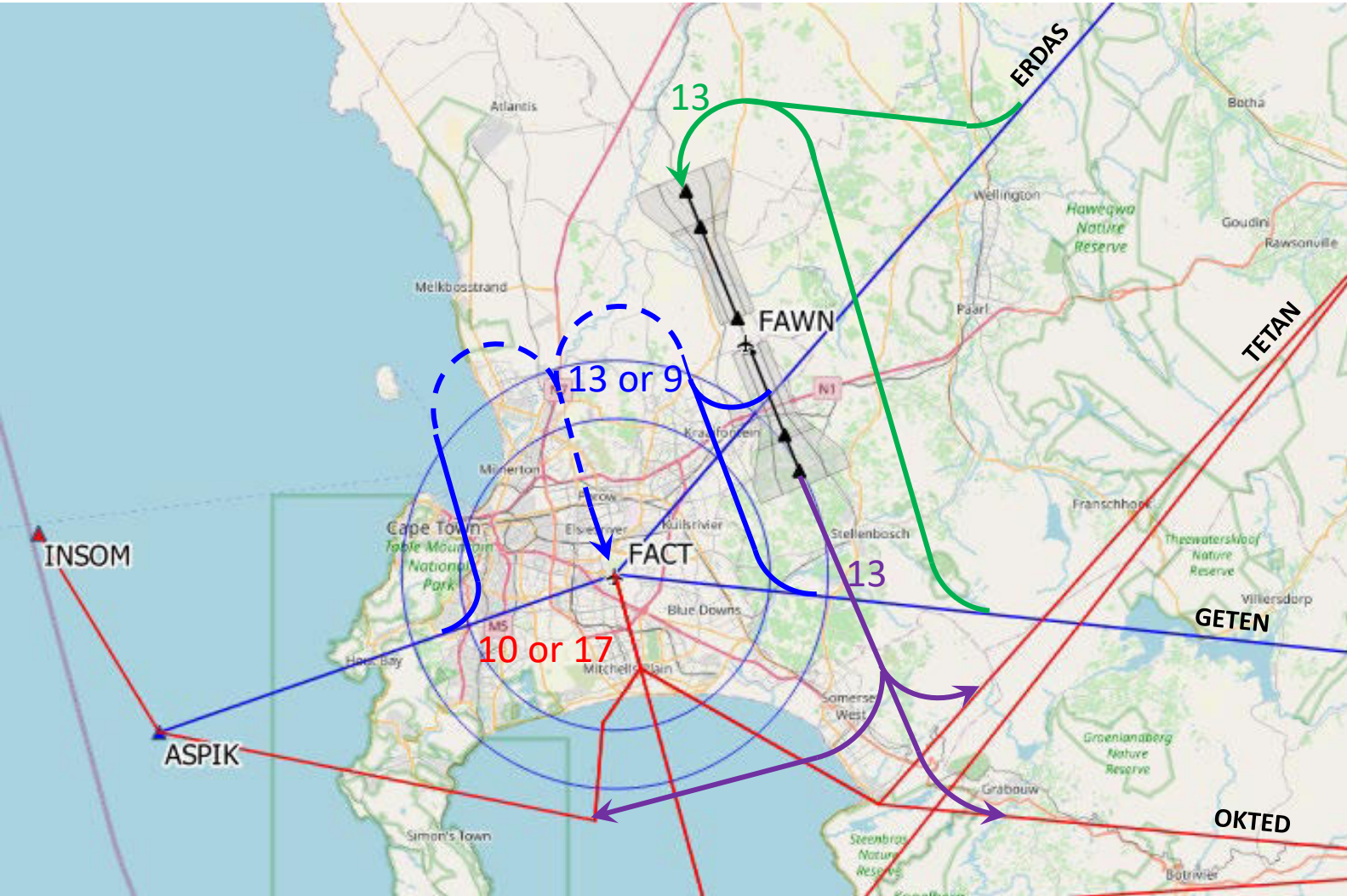

Schematic overview of potential merger of traffic flows in a southern operation with key capacity indicators

TAAM Simulation

Fast Time Simulation

A TAAM simulation of the proposed CONOPS will enable visualization and further analysis.

The simulation is intended to assess the integration of the proposed CWA developments with the existing CTIA airspace and surrounding airports and the impact, limitations and constraints thereof. In addition, the study aims to contribute to the Noise Impact Assessment by providing flight tracks, track segments and flight operations.

Total Airspace and Airport Modeler (TAAM) will be used to simulate the study given its capabilities for modelling at a very high level of detail and closely representing reality in terms of applicable separation standards and flights procedures. It also allows analysis of current and future airspace operations.

The simulation process follows the steps outlined below.



Input Data

- Airports
- Waypoints
- Routes
- Aircraft Performance
- Flight Traffic Schedule



Simulation Environment

- Airport Layout
- Airspace Sectorization
- SID/STAR Design
- Flow Management
- Airspace Rules



Output Data

- 3D Viewer

Baseline Model – Cape Town International Airport (FACT)



Baseline Model – Cape Town International Airport (FACT)

The Baseline Model uses the following input parameters to establish the current situation

Runway	Preferred runway 19
Flight Schedule	Busiest day 20 April 2022 07h00-07h59
Airspace Sectors	
CTR	GND – 2500ft
TMA (A - E)	2500ft – FL145
CTA	FL145 – FL195
Restricted, Prohibited and Danger Areas	
Waypoints & Routes	As per SAAIP

SID Runway 19	STAR Runway 19
TETAN 1A	ERDAS 1B
KODES 1B	GETEN 1B
IMSOM 1B	ASPIK 1B
OKTED 1B	EVUKI 1B
OKTED 1C	
TETAN 1B	

Alternative Model – Integration of FACT and FAWN

The alternative conceptual model demonstrates the integration between FACT Airspace and expected traffic to and from FAWN taking the following into account.

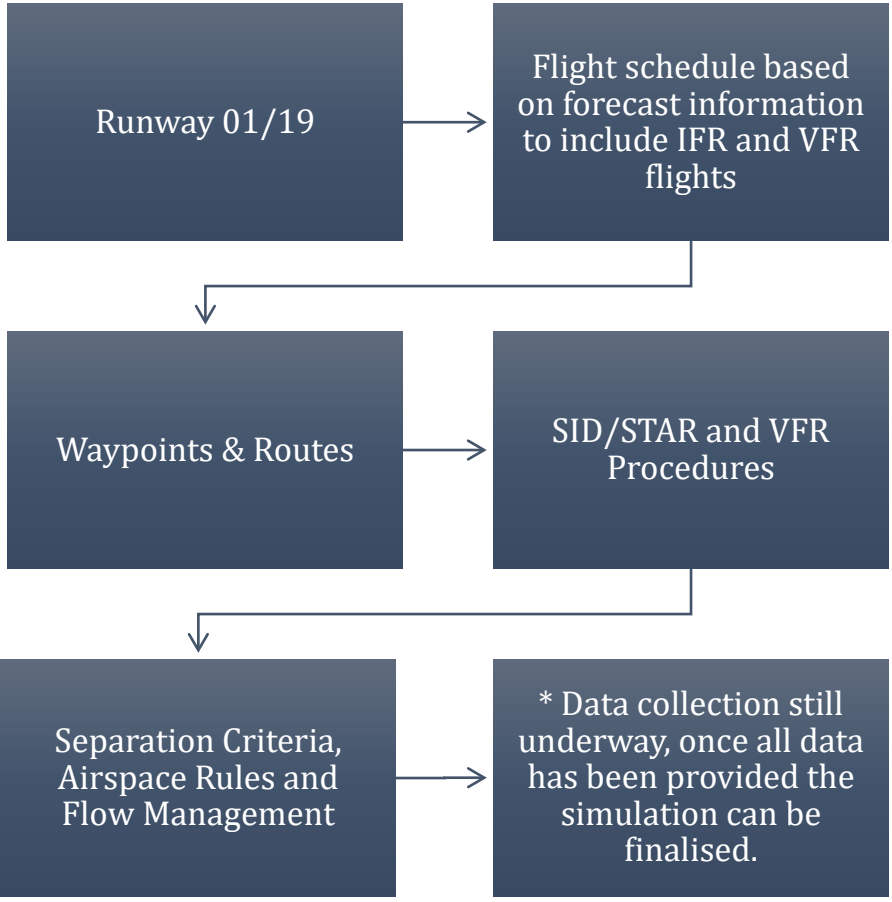

Due to the absence of sufficiently detailed forecast traffic data the TAAM simulation of the Alternative Model has not yet been completed. It is proposed that the simulation is conducted at a later stage when the required busy day flight schedule is made available.

Alternative Traffic

Alternative Traffic

Helicopter Operations

Helicopter operations could be introduced into FAWN. Depending on the type of operations certain considerations need to be taken into account.

Type of helicopter operation:

- Charter operations
- Firefighting operations
- Flight Training operations
- Air Ambulances operations

For IFR helicopter flight separate procedures need to be developed and care must be taken how the specific procedures/routes will merge with the other IFR traffic. This can have an impact on the overall runway throughput as well as the lower airspace segments.

The impact on VFR helicopter flight is expected to be less on the runway throughput, provided necessary clearance distances are adhered to. Nevertheless, procedures and routes need to be developed and protected.

Firefighting and air ambulance operations typically require quick response to a certain location or area. The procedures and airspace should accommodate such requirements.

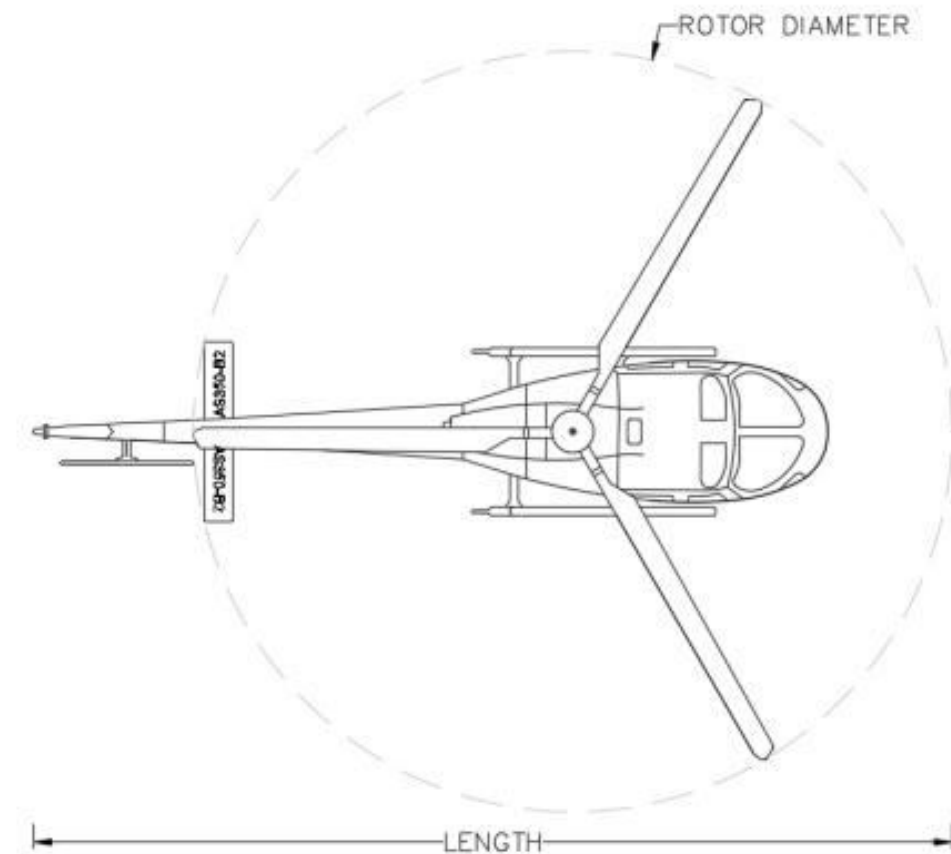

Alternative Traffic

Urban/Advanced Air Mobility consist of several novel traffic types that need to be integrated into conventional operations, including unmanned aircraft

Many developments in the field of aviation are rapidly taking place and new aircraft types are continuously coming onto the market. Some are electrically powered, some have vertical take-off and landing capabilities, and many offer opportunities for aviation in urban environments. Together, these novel aircraft operations are referred to as Urban Air Mobility (UAM) or Advanced Air Mobility (AAM). Within the unmanned operations the RPAS (Remotely Piloted Aircraft System), commonly known as drones, will operate through a certain allocated airspace. Although these type of operations are still under development certain aspects are known to ensure a safe operation.

For the IFR RPAS operation the procedures should be designed to minimize impact on IFR traffic. Especially considering the loss link procedures in which typically a RPAS will fly to certain waypoint and will loiter until communication is restored or potentially it can land automatically. Before each RPAS flight it must be known what the loiter waypoint is and how the route towards the loiter waypoint will be executed (altitude, speed, route and endurance) during the flight.

For RPAS operations in uncontrolled airspace the 'detect and avoid' becomes a critical aspect. This is key as in uncontrolled airspace the pilots themselves are responsible to maintain a safe separation from each other.

Regulations around the infrastructure and airspace requirements for UAM/AAM and RPAS are still under development.

Unmanned Aircraft Traffic Management Systems may be considered should such RPAS traffic increases to levels that would require automated management of the RPAS.



Example of EVTOL aircraft, from eveairmobility.com



Example of cargo drone, from dronumics.com

Airspace

Airspace Design Considerations

Airspace must be (re-)designed to contain the procedures at FAWN, taking into account the required capacity, all the various traffic flows and the existing airspace around FACT

Air Traffic Control and the type of service being rendered at FAWN will be some of the determining factors to consider when developing airspace for FAWN.

A similar shape ATZ to the Cape Town CTR could be developed for FAWN. This racecourse pattern will assist in protecting IFR procedures developed for FAWN runway 01 and runway 19.

Airspace will require certain restrictions on the flow of VFR traffic around the Cape Town CTR and FAWN ATZ. An ATZ at FAWN will be from Ground to 2500 FT ALT, the lower level of the FACT TMA A. Standard operating procedures must be developed to ensure efficient transition from the Cape Town TMA to the Cape Winelands ATZ.

The boundaries of the FAD 69(A) will have to be reconsidered to enable IFR procedures for FAWN to be implemented.

Many factors affect the airspace capacity and the impact each these factors could have is highly dependent of the local circumstances. The image on the right provides an overview of factors affecting airspace capacity. The ICAO Doc 9971 Manual on Collaborative Air Traffic Flow Management contains the following remarks about airspace capacity:

- “It would be extremely complex to establish a universal rule to calculate capacity. Capacity can be affected by so many variable and external considerations that standardization is simply not possible. It is therefore up to each ANSP to decide how to determine its capacity by choosing from either basic methods on observation or highly sophisticated mathematical models.”
- “Regardless of the method chosen to establish capacities, it is strongly recommended that any major calculated increase in capacity be implemented in an incremental way. This will allow real-time experience to be fed back into the models used and will also foster air traffic controller acceptance of the calculated capacity increase.”

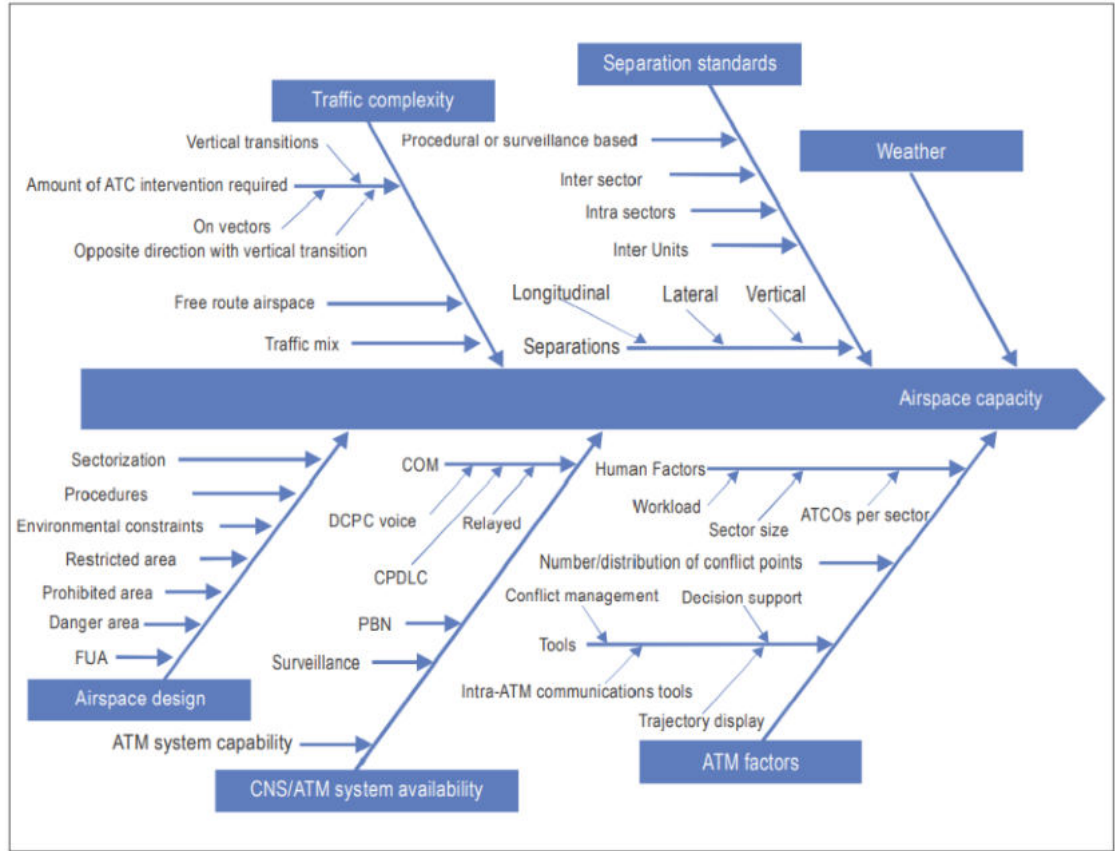

Factors affecting airspace capacity, from ICAO Doc 9971

CNS-ATM Systems

Navigational Aids

Airside Systems required to facilitate traffic in line with the airspace CONSOPS

FAWN will be a Code 4E instrument approach runway. The following Navigational Aid (Nav aids) are considered for FAWN:

1. Instrument Landing System (ILS)
2. Ground-Based Augmentation System (GBAS)
3. Doppler Very High Frequency (VHF) Omni Directional Range (DVOR)
4. Distance Measurement Equipment (DME)

Instrument Landing System

An Instrument Landing System (ILS) is a precision approach Navigational Aid. Under good visibility weather conditions, pilots have sufficient visibility to safely land the aircraft on the runway. When the visibility conditions deteriorate however, pilots must make use of ILS equipment to assist them in proper guidance during landing.

The ILS consists of the following main components:

- Glidepath
- Localiser
- Equipment Shelters
- Field Monitors

Considerations

- When a Distance Measurement Equipment (DME) is col-located with the ILS then it is referred to as ILS/DME. An ILS/DME enhances operations can be considered for the aerodrome.
- When an ILS is proposed for a runway then the category (CAT) of the ILS is considered. The different category are based on the level of visibility at the runway and the decision height as shown below:

Category	Decision Height	RVR Requirement
CAT I	>=60 m	>= 550 m
CAT II	>=30 m	>= 300 m
CAT III A	< 30 m	>= 175 m
CAT III B	< 15 m	>= 50 m

- It is understood that the preference is for the runway to operate at the same category at FACT, which currently has CAT II operations. A CAT II/III approach would require a higher climb gradient which influences the decision for FAWN's category.
- It should be noted that there is no specific requirement or regulation for alternate airports to be the same category as the original destination airport.
- Any considerations on the CAT would also impact the other Airfield infrastructure such as the Aeronautical Ground Lighting (AGL) and Meteorological (MET) Systems but more essentially the geometry of the airport, such as holding positions.
- Siting of an ILS and the feasibility of it are to be considered. The key influencers are:
 - The critical and sensitive areas.
 - The building restricted area or basically clearance from obstacles that would hinder the operation of the ILS.

Recommendation

- A CAT II/III ILS is proposed for FAWN. CAT II/III approach would require a higher climb gradient therefore the categorisation will need to be investigated further at a later stage.
- Considering the cost of an ILS and other siting requirements, it is recommended that a single ILS be procured for the primary direction at FAWN. The costs and benefits of an ILS for both directions should be further investigated.

Navigational Aids

Other Navigational Aids considered for FAWNS

Ground-Based Augmentation System (GBAS)

Global Navigation Satellite System (GNSS) can support area navigation operations, which allows efficient flight routing. Ground-Based Augmentation System (GBAS) is a Global Navigation Satellite System (GNSS)-based precision landing system and is standardized by ICAO as a replacement for the ILS and DVOR.

GBAS is a system that provides differential corrections and integrity monitoring of GNSS in the vicinity of the host airport. GBAS yields the high accuracy, availability, and integrity necessary for Category I, and recently extending to Category II, and III precision approaches.

The GBAS ground station is formed by reference receivers (RR) with their antennas installed in precisely surveyed points. The GBAS also comprises of a Very High Frequency (VHF) Data Broadcast (VDB) antenna that broadcasts processed information from the receivers for each navigation satellite in view as shown in the image below:

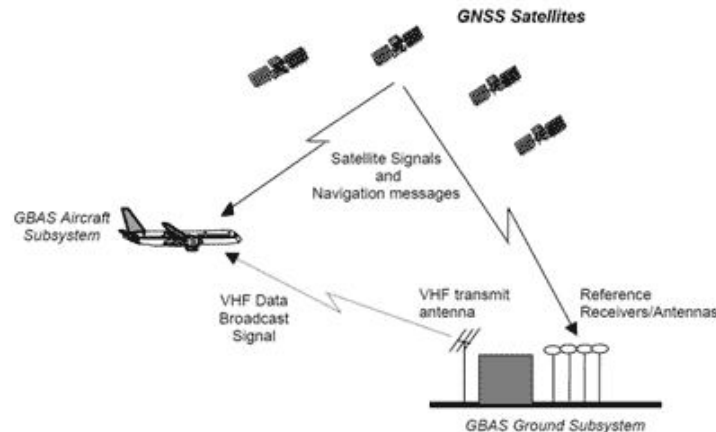

Considerations

- The GBAS is considered the replacement for the ILS and DVOR.
- In comparison to these systems the siting of the GBAS is considered slightly more flexible.
- Operationally, the critical and sensitive areas around the ILS make movements limited during ILS operations and therefore around the runway. These areas where the movement is restricted can be reduced with a GBAS (subject to siting).
- GBAS can serve both approaches.
- CATI GBAS has been regulated with CATII/III regulations currently being developed.
- The fleet would need to be equipped for GBAS Landing System (GLS).
- Satellite Based Augmentation System (SBAS) is a wide range (regional or even continental) system. Through the use of geostationary satellites that broadcast augmented information. The SBAS does also consist of ground based components that receive the GNSS information. This is developing technology and as yet may be considered, however compared this system is still in the early stages of development and implementation.

Recommendation

The GBAS is recommended for the ultimate developments at the airport, but this would be subject to further investigations on the ATM forecast and fleet mix. The main drawback of the GBAS is that the aircrafts need to be GLS equipped so for this system to be beneficial to the airport then more than half the fleet should be able to operate with the GBAS.

Navigational Aids

Non-Precision Approach Nav aids for FAWN

Doppler VHF Omnidirectional Range (DVOR)/Distance measurement Equipment

The Doppler VHF Omni Directional Range (DVOR) system provides bearing information to and from the station. In general, the VOR is aligned with the magnetic North direction. When a Distance Measurement Equipment (DME) is also installed with a DVOR, this is referred to as a DVOR/DME. The DME measures the distance of an aircraft from the DVOR/DME.

Considerations

- The system enables non-precision instrument approach to the airport.
- Most airports in South Africa have DVOR/DME equipment and many aircraft operators make use of this, either for approach procedures or for other (measurement) purposes. Some (older) aircraft are not equipped for RNAV procedures and make use of these DVOR/DME procedures where available.
- In some cases, aircraft can make use of DVOR/DME equipment installed at other sites nearby an airport if the airport itself does not have the equipment (e.g. the VOR/DME used at FACT).
- The siting of the DVOR is quite restrictive and limits the infrastructure/obstacles up to 300m from the DVOR/DME with almost no metallic content within the first 100m.
- The DVOR structure itself requires a space reservation of approximately of a 30m radius.
- As mentioned earlier it should be noted that the GBAS is considered a replacement for not only the ILS but also the DVOR.
- The National Airspace Master Plan, PBN Roadmap, etc. are all documents and plans supporting a shift towards space based navigational aids.

Recommendation

- We recommend that neighbouring DVOR/DMEs be considered for approach routes to FAWN.
- A DME can be recommended (possibly just co-located with ILS) for FAWN rather than a DVOR/DME combination. The DME can provide non-precision aid to aircrafts as well.



Typical DVOR/DME

Meteorological Systems

The weather is a critical part of aviation and it is often the main factor for determining whether the aerodrome can continue to be operational

Automated Weather Observation System (AWOS)

The Automated Weather Observation System (AWOS) is a system that measures actual weather conditions with a combination of sensors or instrumentation located within certain target areas (in this case aerodromes).

The following AWOS sensors are often part of the AWOS suite:

- Wind Speed & Direction
- Temperature/Humidity
- Barometric Pressure
- Precipitation
- Visibility & Instrument Runway Visual Range (IRVR)

Instrument Runway Visual Range (IRVR): RVR provides air traffic services (ATS) and pilots with information on the visibility conditions of the Runway, particularly low visibility conditions such as fog, rain, sandstorms or snow. RVR is an assessment of the whether the conditions are below or above the required minima for landing and take-off.

One of the techniques for determining the RVR is an instrumented technique; Instrument IRVRs.

Considerations

Other than the local weather conditions, the category of the runway and ATM procedures influence the type and scale of MET equipment at an aerodrome:

• Visibility: Ceilometers

It is mandatory to automatically measure the cloud height at aerodromes with runways intended for CAT II and III instrument approach and landing operations in accordance with ICAO Annex 3 provisions.

• Visibility: IRVRs

In accordance with ICAO Annex 3 the measurement of the RVR at aerodromes using instrument RVRs for runways intended for precision approach CAT I/II/III is required. Below is a table that summarises these requirements:

ILS Category:	Position RVR Transmissometer		
	Touch down appr.300m	Mid runway appr.1000m	Stop end appr.1500m
Category I	X	-	-
Category II	X	X	-
Category III	X	X	X
	Maximum 120m from runway centreline. At a height of 2.5m above the runway. Construction: light and frangible. CAT III runway may need an additional RVR position in view of the r/w length.		

Recommendation

- A complete AWOS, equipped as a minimum for a precision approach runway is recommended for FAWN. Subject to the Category of the runway, it is to be equipped with IRVRs and Ceilometers. Some of this equipment may already be available.

Visual Aids

Visual aids for low visibility conditions and guidance for aircrafts

Aeronautical Ground Lighting and Signage

To improve runway safety and in partial fulfilment of runway operations under low visibility (including night) conditions, the new AGL would comprise of the following components:

- Light Emitting Diode (LED) based runway lighting system for a CAT II/III runway, with the following sub-components: -
- Approach lighting system (subject to category of the runway)
- Runway threshold lights
- Runway edge lights
- Runway end lights
- Taxiway, Apron and Turn Pad edge lights or markers
- Precision approach path indicator (PAPI)
- Aeronautical Illuminated Signage

Considerations

- The space availability and the local terrain/geography at FAWN need to be considered for the installation of the AGL. The Category of the runway influences this decision. However, for FAWN the AGL actually influences the decision on the category of the ILS.
- The availability of space for a CAT I/II/III approach lights of the AGL system is limited. Whereby:
 - For a non-precision, a simple approach lighting (SAL) configuration is considered. For a SAL the required space is 420m beyond the THR of the runway.
 - For CAT I/II/III the approach lights would extend to 900m beyond the THR.
 - The above (SAL and CAT I/II/III approach lighting length) is shown in the image on this page which compares the SAL with the CAT I/II/III approach lighting layouts.

Recommendations

- The space or land availability for the approach lighting should be further assessed prior to finalizing the CAT of the runway. It is recommended that only the primary direction be equipped for precision approach and therefore CAT I/II/III approach lighting (i.e. extending 900m from threshold 19).
- The secondary direction can then be equipped with only a simple approach lighting system (i.e. extending 420m from threshold 01).
- Displaced thresholds with inset approach lights should be considered to avoid the need for approach lights to be placed on adjacent properties.

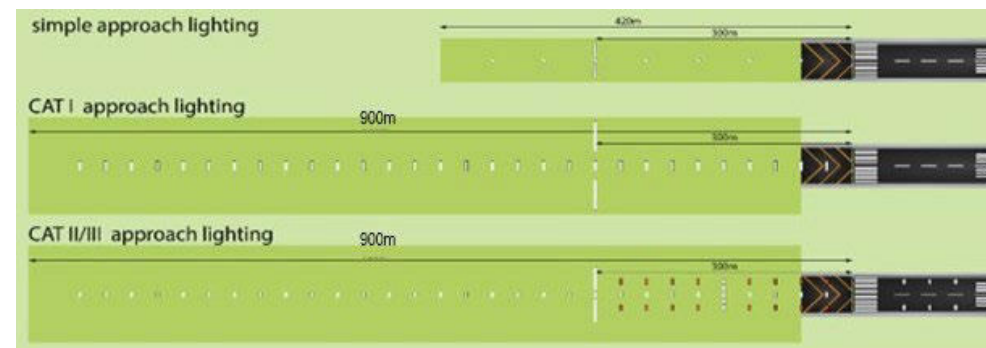

Comparison overview of SAL and CAT I/II/III approach lighting

Approach Lighting RWY 19

Example of displaced threshold and inset approach lighting on RWY 19

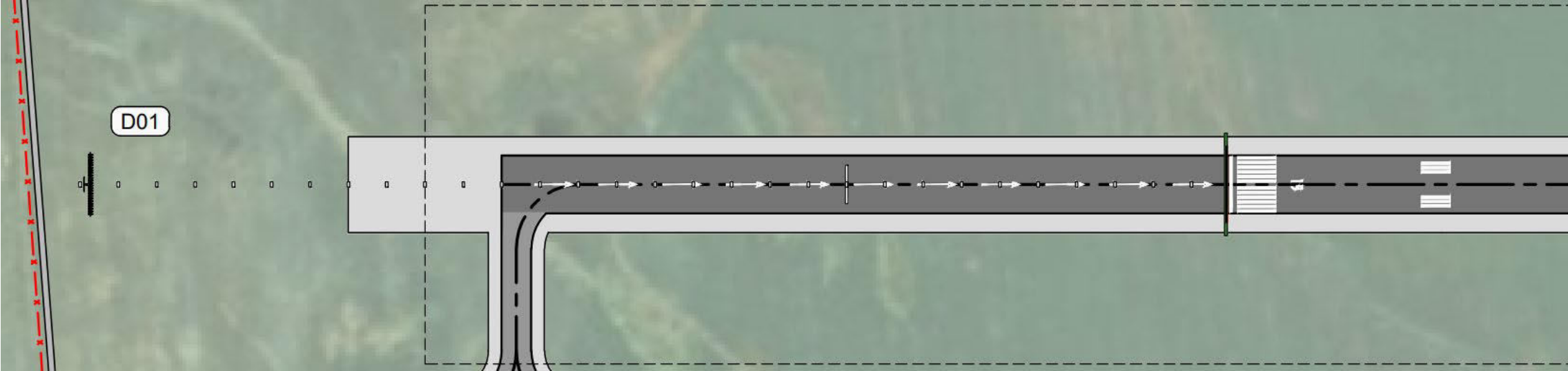

Approach Lighting RWY 01

Example of displaced threshold and inset approach lighting on RWY 01

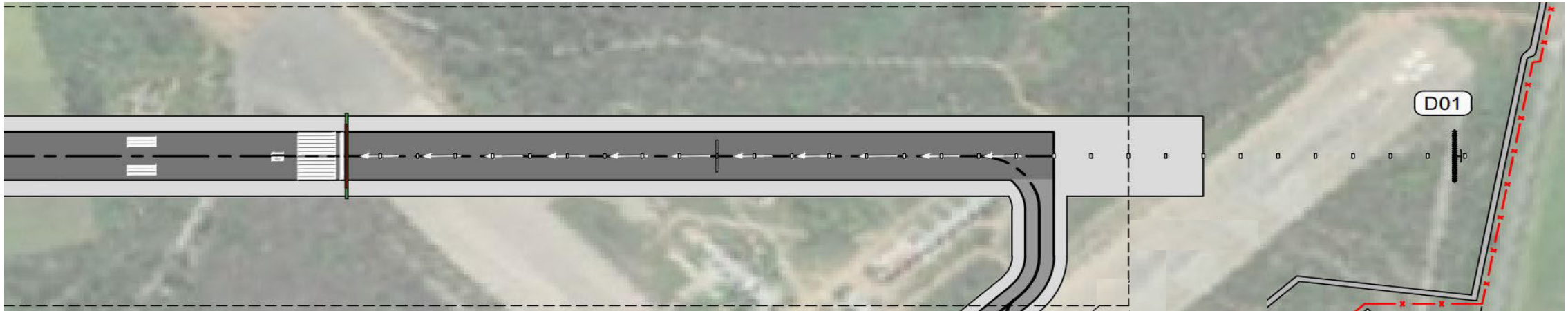

Air Traffic Management Systems

A combination of digital and conventional ATM Solutions are proposed for FAWN

Air Traffic Communication and Control Systems

There are various communication systems required for ATM that include ground-ground communication and air to ground communication systems.

The following ATM Communication Systems are required for FAWN:

- Wireless Telecommunications/Radio systems (VHF/UHF)
- The Voice Communication Control System (VCCS)
- Digital Voice Recording System (DVRS)
- Crash Alarm System (CAS)
- Dynamic Automatic Terminal Information Service (D-ATIS)
- Aeronautical Message Handling System (AMHS)

Considerations

- The equipage of an Air Traffic Control Tower (ATCT) or Aerodrome Flight Information Services (AFIS) is dependent of the aeronautical CONOPS and client/stakeholder requirements. Therefore, the above list may vary (reduce) for instance in a Remote Tower System should it be considered rather than a traditional ATCT.
- A Basic AMHS can be considered for FAWN or a user agent license extended/ borrowed from CPT/JNB is another option for the AMHS. The later, is subject to licenses and agreements with either airport.
- As mentioned earlier (under Alternative Traffic), Unmanned Aircraft Traffic Management Systems may be considered for FAWN. However, this is not considered a hard requirement unless the movements increase to a level that warrants such a system.

Recommendations

- AMHS user agent licenses be bought as an extension of existing AMHS at other airports in South Africa (preferably CPT) as the first option for the AMHS. This possibility will need to be investigated further at a later stage.
- Remote or Digital Tower be considered for FAWN. This is discussed further in subsequent chapters

Remote or Digital Tower Solution

- Virtually all modern controlled airports are equipped with a staffed tower to provide air traffic services to operate and maintain arrival, departure and ground movement for commercial and non-commercial aircrafts.
- However, increasing pressure to reduce costs and modernize service is compelling Air Navigation Service Providers (ANSPs) to rethink the status quo and to explore new concepts for air traffic management (ATM), such as remote tower solutions (RTS).

Considerations

- Remote or Digital Towers are considerably lower in CAPEX costs. Should the Digital/Remote Tower Control Centre be located offsite (outside the airport premises) and/or shared with other airports then the OPEX costs associated with staffing would also reduce (subject to air traffic movements).
- The location of the Tower Control Centre would need to be assessed. There are two options for FAWN. The Control Centre can be remote and shared with other airports or even local (within the airport) and therefore within the vicinity of the Digital Tower (cameras).
- Having the Digital Tower Control Centre within the airport would ensure that any limitations or risks in the Wide Area connection (communications line) between the control centre and the digital/camera remote tower (at FAWN) is removed.

Recommendations

- A Digital Tower Solution should be considered for FAWN with the location of the Traffic Control Centre (remote or local digital) to be investigated at a later stage.

ATC

Air Traffic Control

Local ATC will be required at FAWN to enable the implementation of controlled airspace

Local ATC will be required at FAWN to operate the proposed controlled airspace. This could be facilitated with a conventional physical tower, or remote tower solutions can be considered. Remote tower solutions are developing rapidly and have been deployed successfully in many countries.

It is recommended that operating procedures are developed to ensure seamless integration of ATC at FAWN and FACT. ATCO capacity and workload will be key considerations in this regard. A gradually buildup of the air traffic volume at the start of the operation at FAWN will aid in properly fitting in the FAWN traffic with FACT traffic.

In order to aid an ATCO with workload the following can be considered:

- A proper airspace review and analysis may prescribe sectorization of the airspace to support airspace for both FACT and FAWN.
- (Extended) Arrival manager (EMAN/AMAN) to provide better predictability of the inbound traffic.
- Departure manager (DMAN) to provide an optimized planning for outbound traffic.
- Main routes should procedurally be separated from each other to reduce amount of interactions by the ATCO.

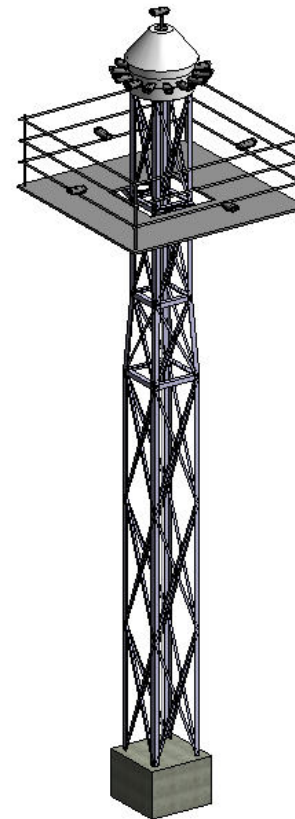

3D Model of Digital Tower (NACO) Remote ATC Tower at Groningen Airport Eelde

Air Traffic Control

Benefits of Digital Tower Solution

Cost-Efficiency: Remote or digital air traffic control systems can be more cost-effective to implement and maintain compared to traditional physical control towers. This can be particularly advantageous for smaller airports like Cape Winelands, where cost considerations are significant.

Enhanced Safety: A remote system allows for advanced surveillance and monitoring of air traffic, providing controllers with real-time data and alerts. This proactive approach enhances safety by identifying potential conflicts and hazards early on.

Adaptability: Digital systems can be easily upgraded and adapted to evolving aviation technologies and regulatory requirements. This flexibility ensures that the airport remains up-to-date with the latest advancements without the need for extensive infrastructure changes.

Scalability: As air traffic increases over time, a remote system can accommodate growing demand without significant physical expansions. This scalability is crucial for airports that anticipate increased traffic in the future.

Improved Visibility: Advanced camera technology and surveillance tools in remote systems can provide controllers with clearer and wider views of the airfield and surrounding airspace. This enhanced visibility improves situational awareness and decision-making.

Resource Optimization: Digital systems allow for more efficient allocation of air traffic control personnel. Controllers can manage multiple airports from a centralized location, optimizing staffing levels and reducing the need for on-site personnel.

Implementation

Way Forward

Moving forward with the implementation of the Airspace CONOPS for FAWN will require formal industry consultation and design processes to be followed

Industry consultation

This Airspace CONOPS forms a starting point for further development of the airspace and flight procedure design that may lead to implementation. Stakeholder consultation will play a key role in this process, in line with CDM principles. This may include both direct engagement with key players and various industry representation bodies as well as through statutory NASCOM and the CNS/ATM Implementation Committee.

The TAAM simulation will illustrate an overview of this CONOPS to visualise the proposals contained in this report. This may be a useful tool in engagements with industry and public, as part of the EIA process.

Further investigations

Key areas to be investigated and developed further include the following:

- Comprehensive inventory of fleet capabilities to determine the need and desire for certain navigational (and visual) aids.
- Detailed forecast of the peak aircraft movements per hour during the day, taking into account not only the forecast traffic at FAWN but also potential growth at FACT.
- Detailed analysis of airspace capacity and specifically the areas where high traffic volumes can be expected.

ATCO Workload

ATCO workload evaluation will be a continuous process. The CDM process will be followed after the EIA process to start developing the procedures, etc. An airspace evaluation will guide the implementation of new sectors and/or changes in airspace dimensions. The tools mentioned above, EMAN, AMAN, DMAN, etc. should be analysed to confirm their viability towards supporting ATCO efficiency, etc. When considering ATCO tools, etc. it is important to always consider safety as the key priority.

Design of flight procedures and airspace

The design of the flight procedures goes hand in hand with the design of the airspace. The applicable procedures are protected and controlled within its boundaries of a dedicated volume of airspace. For the development of the flight procedures it is imperative that the key-stakeholders are engaged (ANSP, aviation authorities, operators).

Key considerations in the design of preliminary procedures for FAWN include:

- Additional WGS84 topographical surveys, taking into account specific requirements for precision approach procedures,
- Determine optimal merge and diversion points,
- Infringement with current FACT procedures,
- Compliance with restrictions on NEMPA areas,
- CCO and CDO operations,
- Noise reduction and limitation of environmental impact, and
- ATCO operating procedures and workload.

Key considerations for the airspace (re)design include:

- Adjustment of the 69(A) FAD area,
- Creation of the FAWN ATZ/CTR,
- Further investigation of the combined use of the TMA by FACT and FAWN as well as if adjustments are necessary.

Appendix

Aerodromes within 20nm

For more information refer to Baseline Report

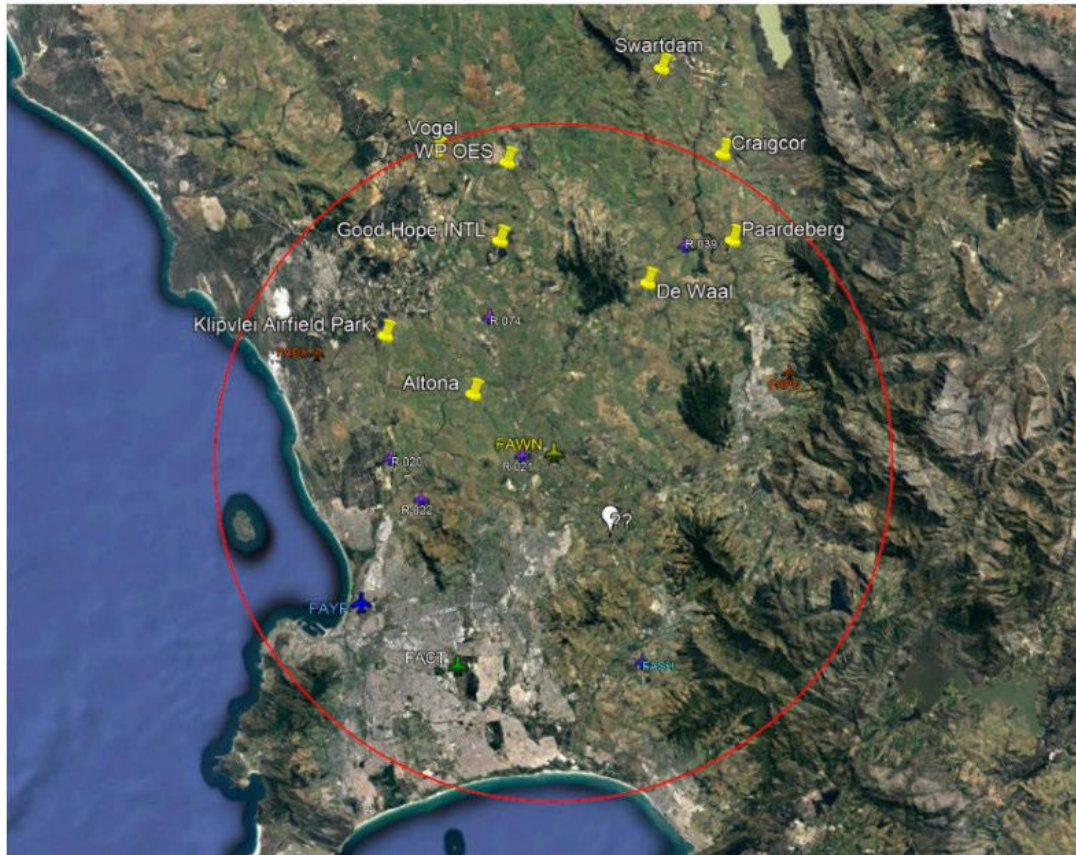

Aerodromes within 20nm of FAWN, from: Baseline Assessment Report (12 August 2022)

No.	Airport/Airstrip/Helistop	Distance from CWA	Surface, facilities and usage	Map Identifier
1.	Grootfontein	+/- 2nm	1 x Gravel/Hanger/Local Farmer	R 021
2.	Unknown airstrip (33°50'52.23"S 18°47'54.99"E)	+/- 5nm	2 x Gravel/Building/ Local Farmer	??
3.	Altona	+/- 6nm	1 x Gravel/No Facilities/ Local Farmer	Altona
4.	Coutermanskloof	+/- 8nm	1 x Gravel/No Facilities/ Local Business	R 022
5.	Wintervogel Flight Park	+/- 9nm	2 x Gravel/Frequency, Hangers & Buildings/ Local Farmers & Training	R 074
6.	Morningstar (WCMC Club)	+/- 9.6nm	1 x Asphalt/Frequency, Hangers & Buildings/ Local & Training	R 020
7.	De Waal	+/- 11nm	1 x Gravel/No Facilities/ Local Farmer	De Waal
8.	Klipvlei Airfield Park	+/- 12nm	1 x Gravel/No Facilities/ Local Farmer	Klipvlei Airfield Park
9.	Good Hope INTL	+/- 12.8nm	1 x Gravel/No Facilities/ Local Farmer	Good Hope INTL
10.	Stellenbosch	+/-13 nm	1 x Asphalt/Frequency, Hangers & Buildings/ General Aviation & Training	FASH
11.	Netcare Blaauwberg Hospital Helistop	+/- 13nm	Helipad/No Facilities/Emergency Helicopters Only	298
12.	Ysterplaat	+/-14nm	1 x Asphalt/Military Facilities/Military & State usage	FAYP
13.	Cape Town International Airport – ACSA	+/- 14nm	2 x Asphalt/All Commercial Facilities/ Commercial International usage	FACT
14.	Diemerskraal	+/- 14.7nm	1 x Gravel/Hangers & Buildings/Local Farmers & Training	R 039
15.	Paarl	+/- 14.8nm	1 x Gravel/No Facilities/ Local Farmers	FAPU
16.	Delta 2000	+/- 15nm	1 x Asphalt/Hangers/ Local Farmers	FADX
17.	Black River Helistop	+/- 15nm	Helipad/No Facilities/ Local Business use	394
18.	Paardeberg	+/- 16nm	1 x Gravel/No Facilities/ Local Farmers	Paardeberg
19.	WP OES	+/- 17nm	1 x Asphalt/Hangers/ Local Farmers	WP OES
20.	V&A Waterfront Helistop	+/- 17.5nm	Helipad/No Facilities/ Local Business use	225
21.	Vogel	+/- 19nm	1 x Gravel/No Facilities/ Local Farmers	Vogel
22.	Craigcor	+/- 20nm	1 x Gravel/No Facilities/ Local Farmers	Craigcor
23.	Swartdam	+/- 23nm	1 x Gravel/No Facilities/ Local Farmers	Swartdam



NACO
a company of Royal HaskoningDHV

AVIATION TRAFFIC & NAVIGATION SERVICES
ATNS

